



Introduction to OSPF

ISP/IXP Workshops

OSPF

- **Open Shortest Path First**
- **Link state or SPF technology**
- **Developed by OSPF working group of IETF (RFC 1247)**
- **Designed for TCP/IP Internet environment**
- **Fast convergence**
- **Variable-length subnet masks**
- **Discontiguous subnets**
- **No periodic updates**
- **Route authentication**
- **OSPF standard described in RFC2328**

Link State

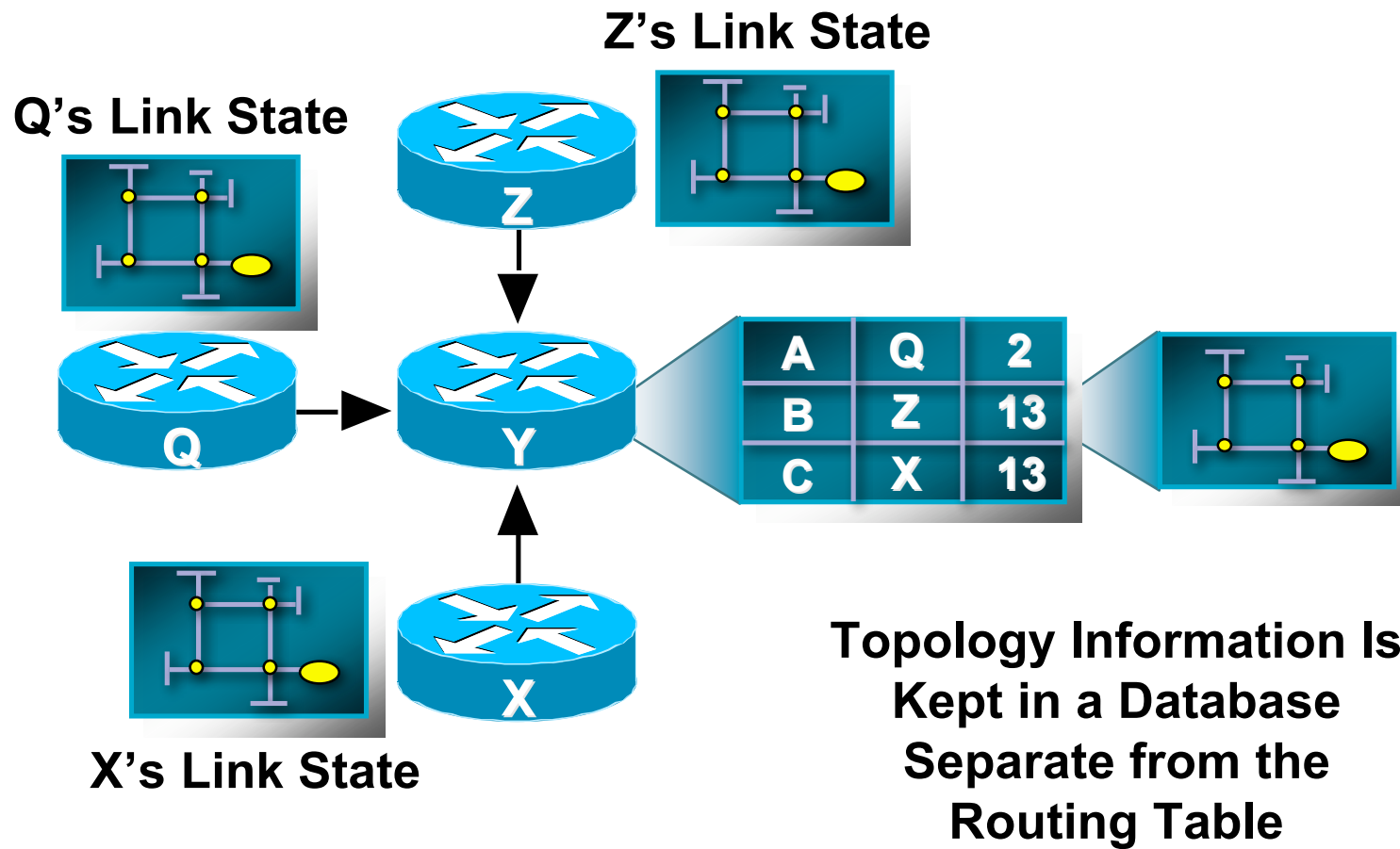

Link State Routing

- **Neighbour discovery**
- **Constructing a Link State Packet (LSP)**
- **Distribute the LSP**
 - (Link State Announcement – LSA)
- **Compute routes**
- **On network failure**
 - New LSPs flooded**
 - All routers recompute routing tables**

Low Bandwidth Utilisation

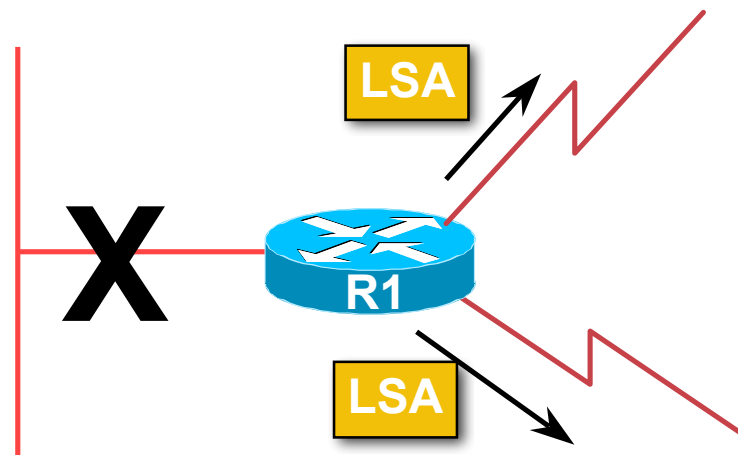

- **Only changes propagated**
- **Multicast on multi-access broadcast networks**

Fast Convergence

- Detection Plus LSA/SPF

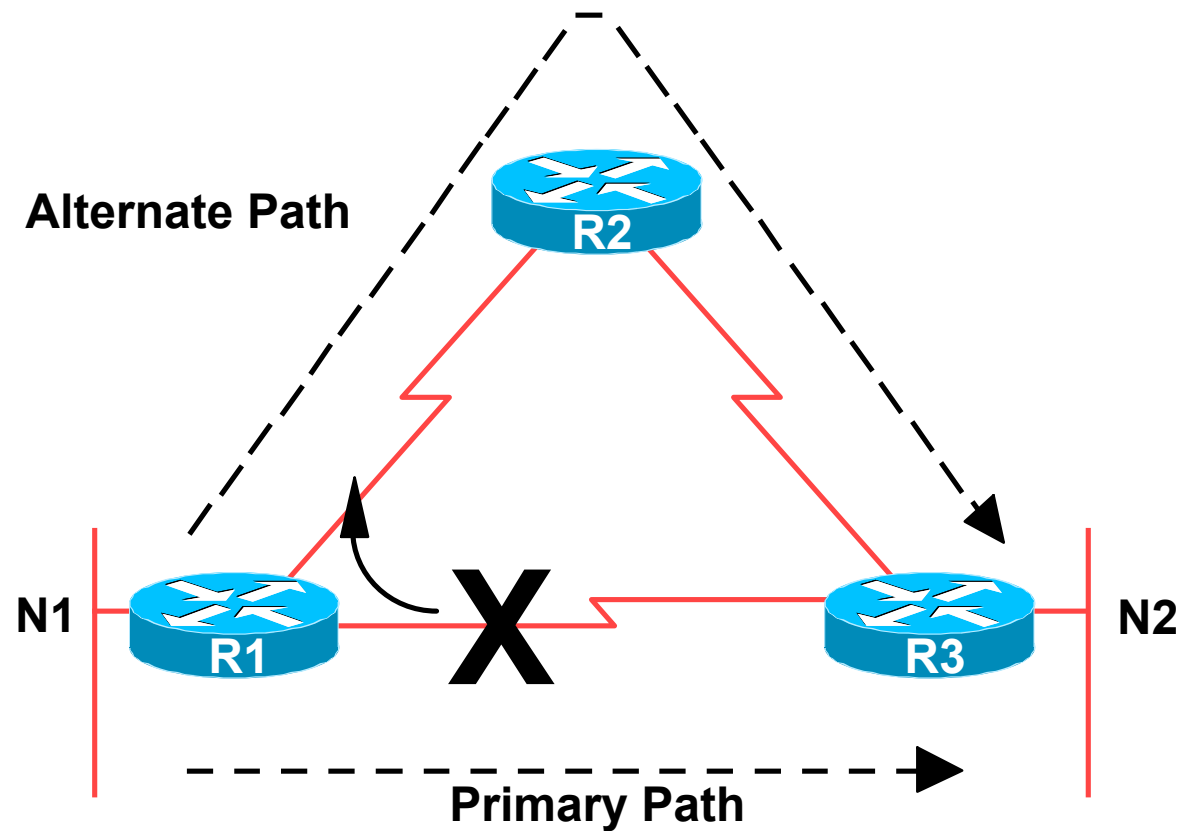

Fast Convergence

- **Finding a new route**
 - LSA flooded throughout area
 - Acknowledgement based
 - Topology database synchronised
 - Each router derives routing table to destination networks

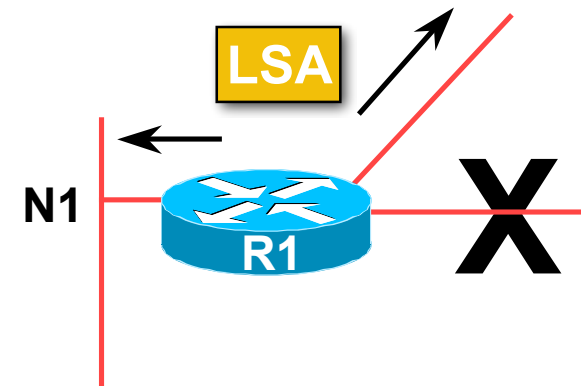

IP Multicast for Sending/Receiving Updates

- **Broadcast networks**

- All routers must accept packets sent to AllSPFRouters (224.0.0.5)**

- All DR and BDR routers must accept packets sent to AllDRouters (224.0.0.6)**

- **Hello packets sent to AllSPFRouters (Unicast on point-to-point and virtual links)**

OSPF Areas

- **Group of contiguous hosts and networks**
- **Per area topological database**
 - Invisible outside the area
 - Reduction in routing traffic
- **Backbone area contiguous**
 - All other areas must be connected to the backbone
- **Virtual Links**

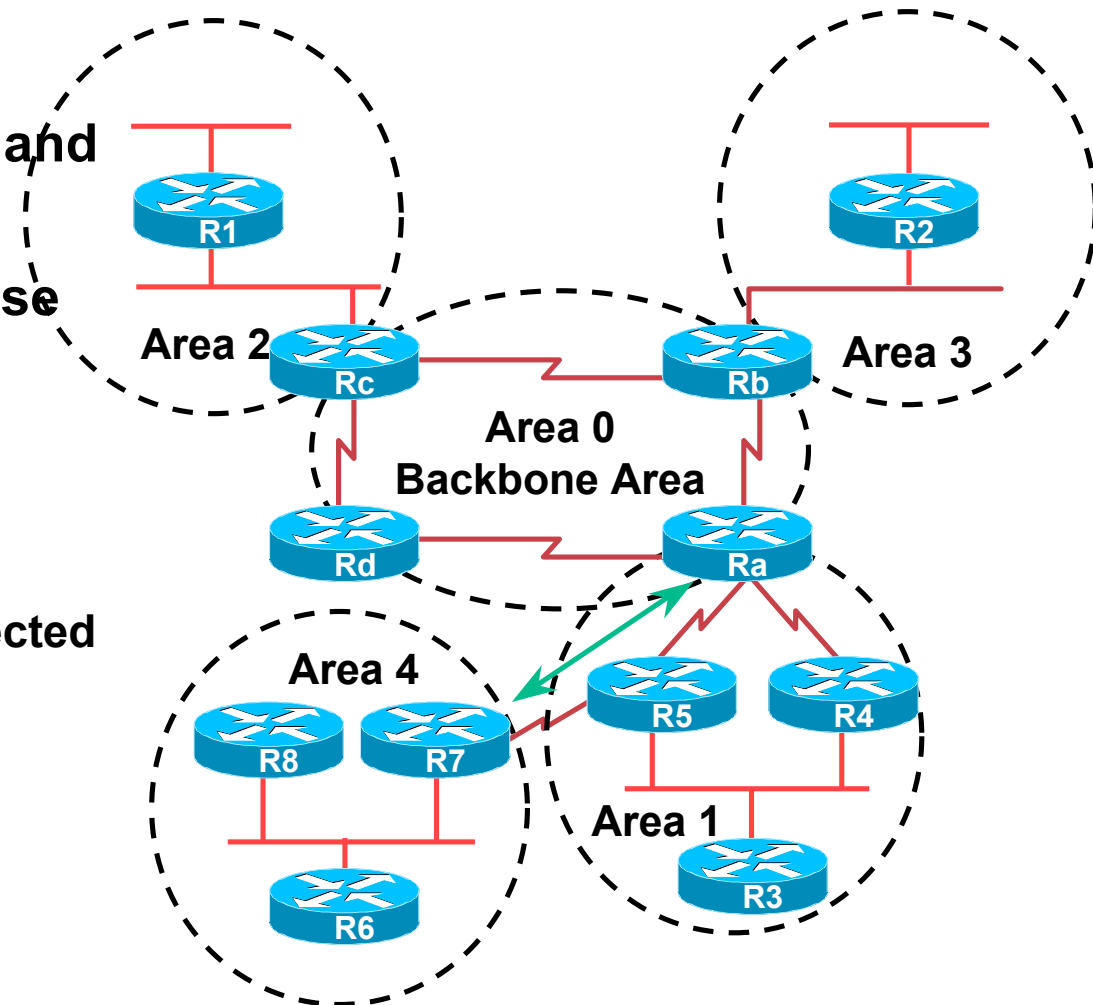

OSPF Route Types

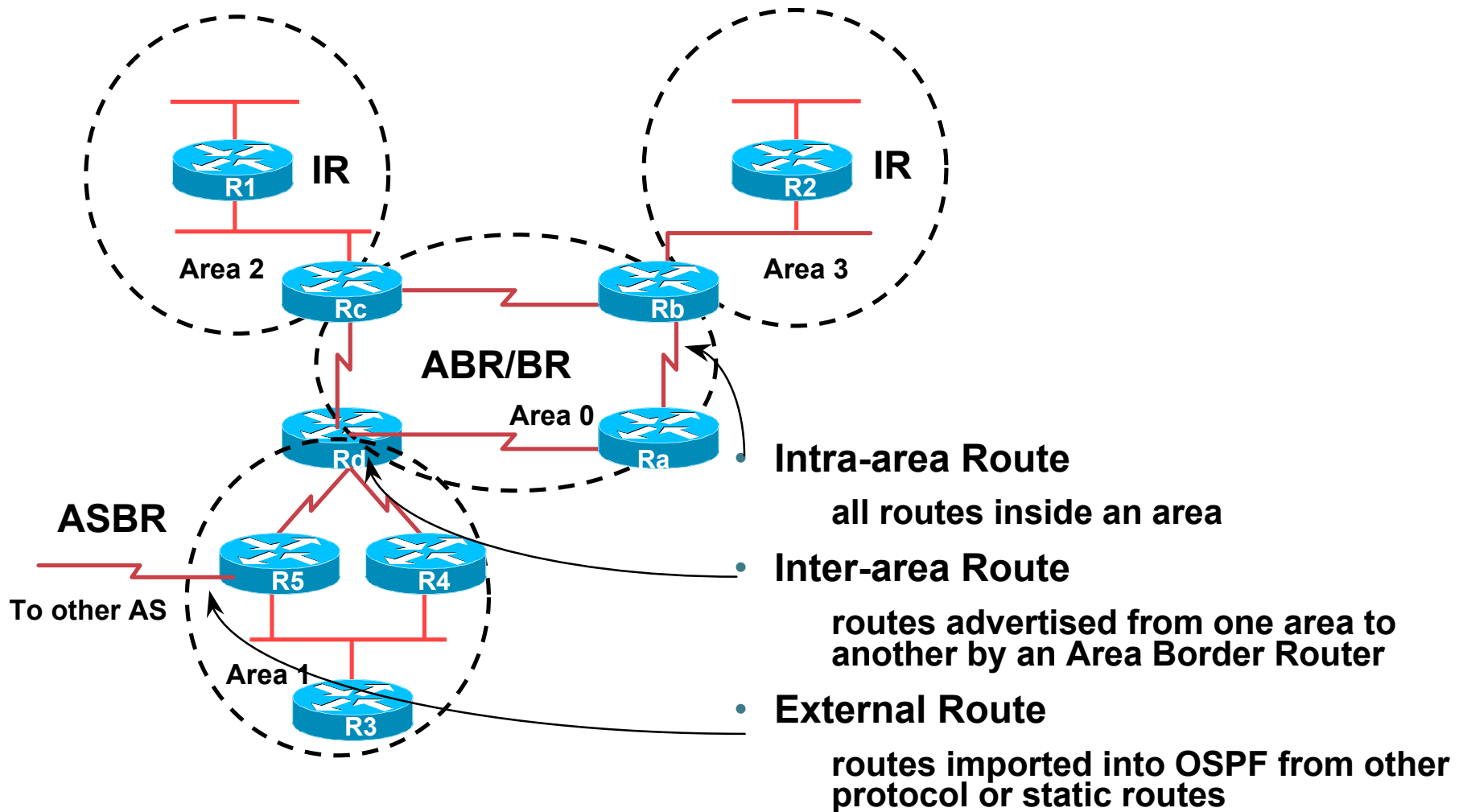

Inter-Area Route Summarisation

- Prefix or all subnets
- Prefix or all networks
- 'Area range' command

With summarisation

Network	Next Hop
1	R1

Without summarisation

Network	Next Hop
1.A	R1
1.B	R1
1.C	R1

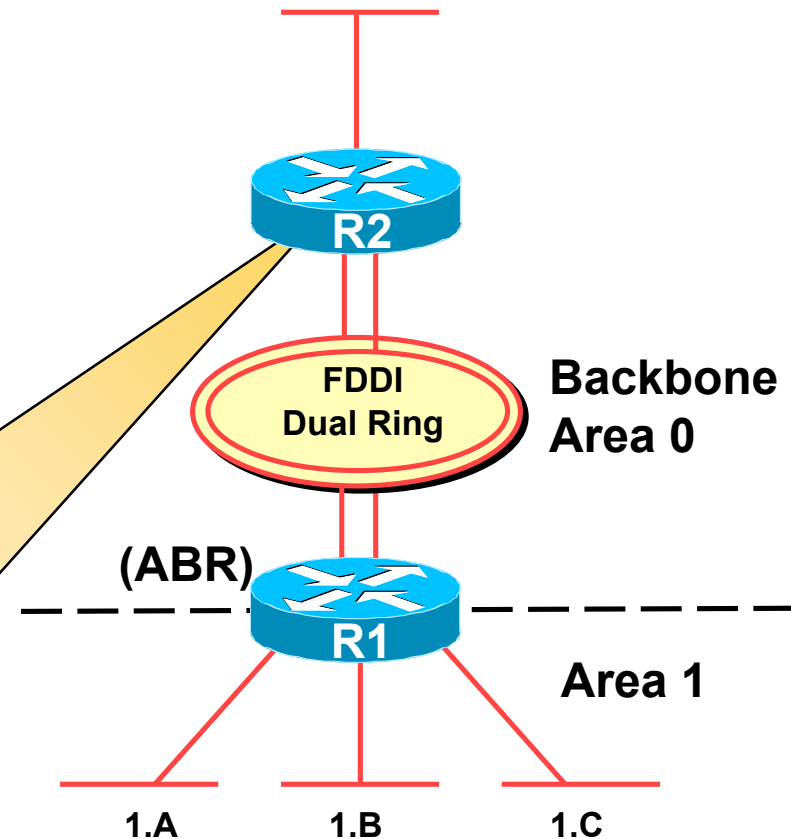

External Routes

- **Prefixes which are redistributed into OSPF from other protocols**
- **Flooded unaltered throughout the AS**
- **OSPF supports two types of external metrics**
 - Type 1 external metrics
 - Type 2 external metrics (Default)

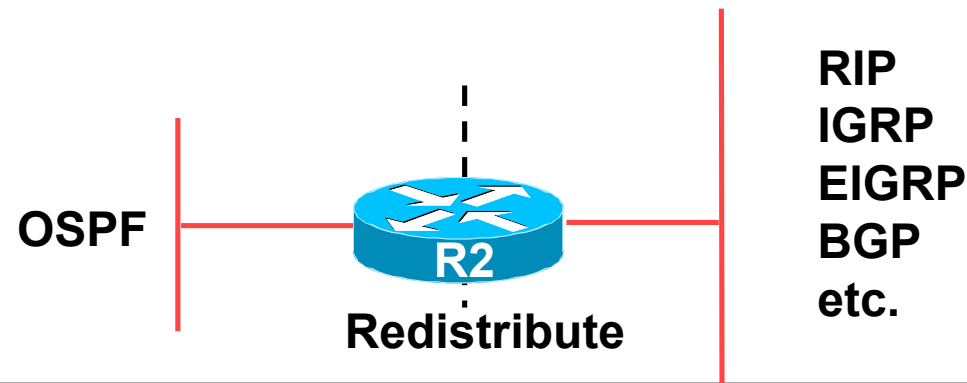

External Routes

- **Type 1 external metric: metrics are added to the summarised internal link cost**

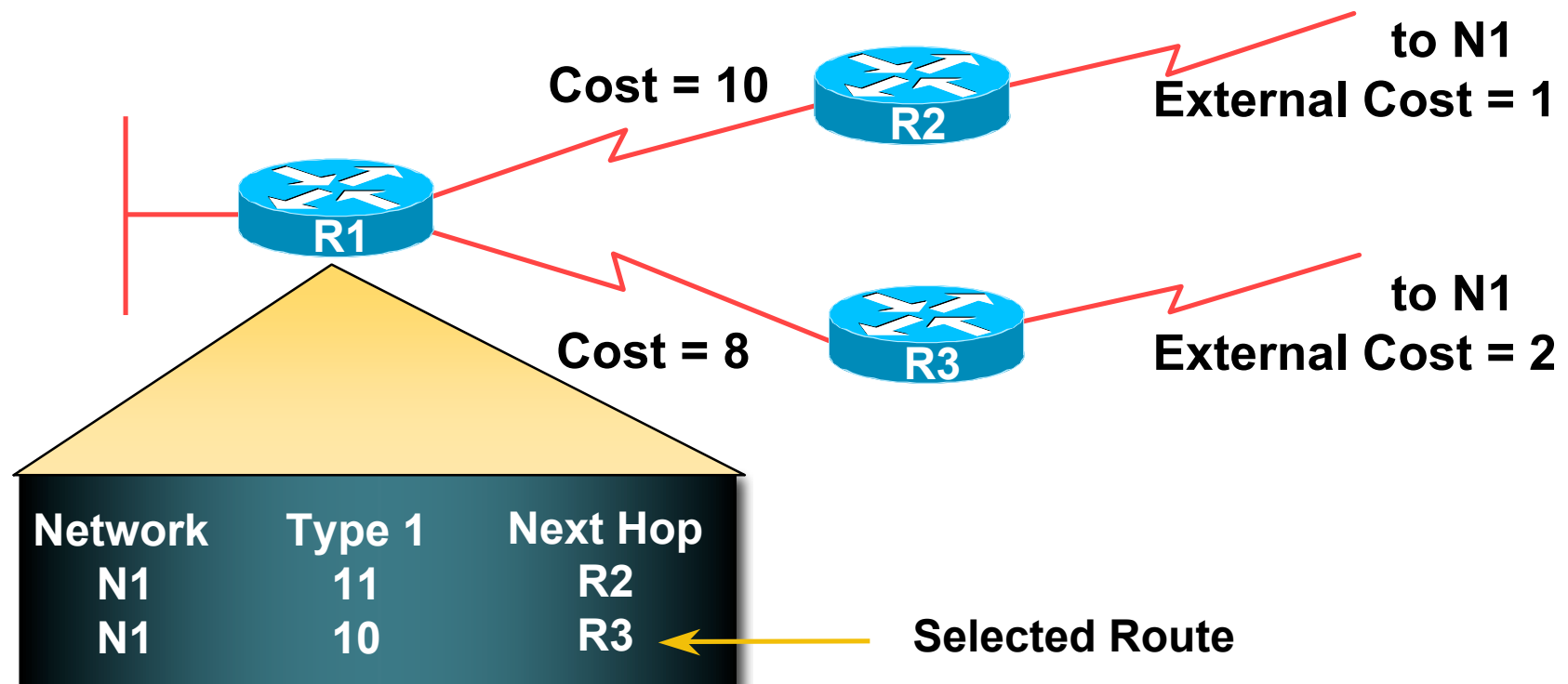

External Routes

- **Type 2 external metric: metrics are compared without adding to the internal link cost**

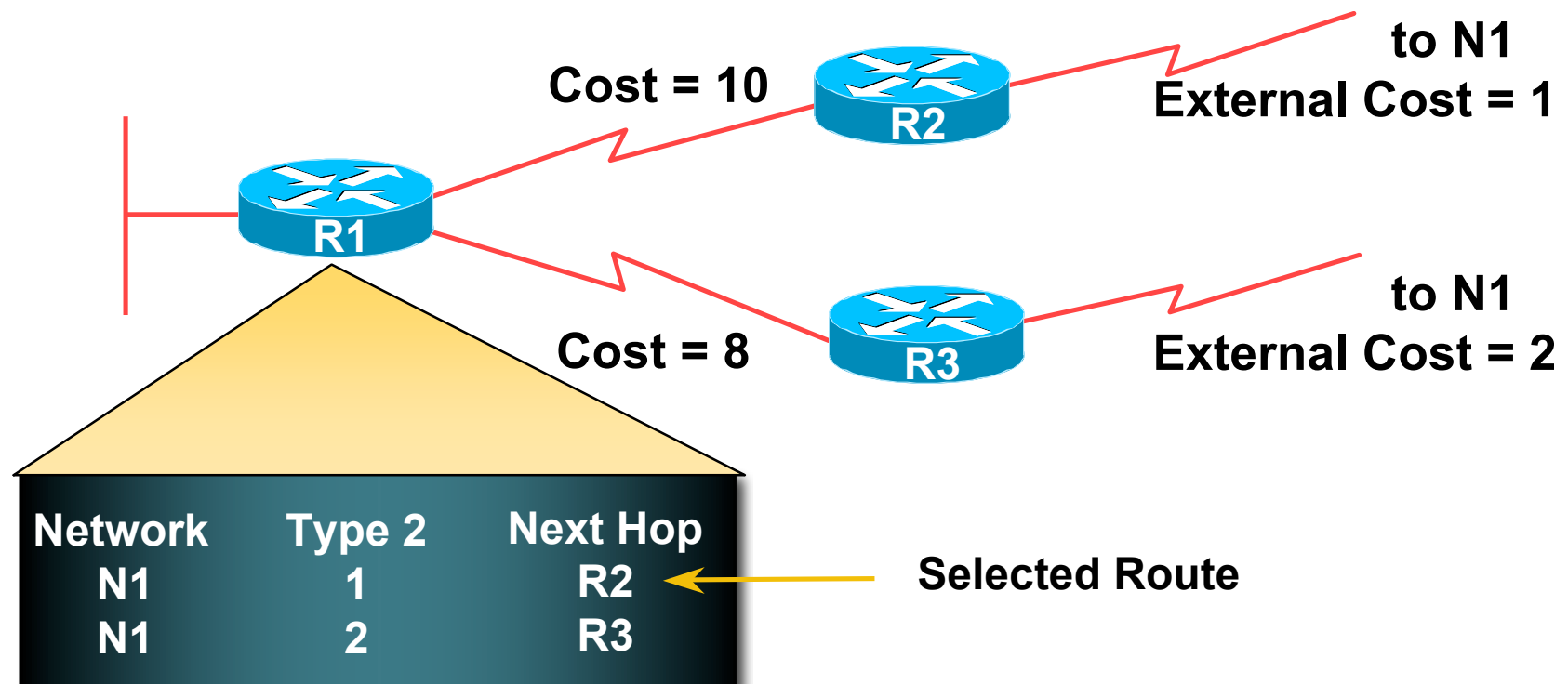

Topology/Link State Database

- **A router has a separate LS database for each area to which it belongs**
- **All routers belonging to the same area have identical database**
- **SPF calculation is performed separately for each area**
- **LSA flooding is bounded by area**

Protocol Functionality

- **Bringing up adjacencies**
- **LSA types**
- **Area classification**

The Hello Protocol

- **Responsible for establishing and maintaining neighbour relationships**
- **Elects designated router on multi-access networks**

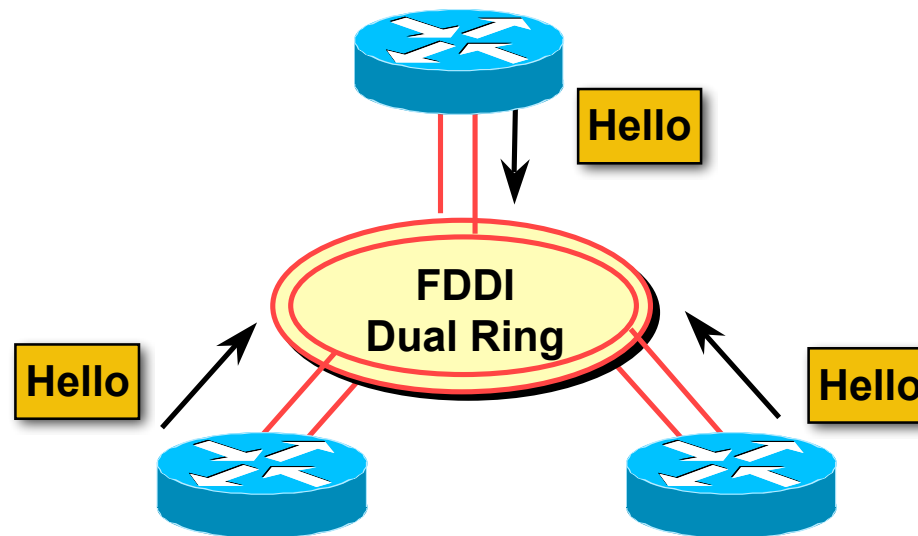

The Hello Packet

- Router priority
- Hello interval
- Router dead interval
- Network mask
- Options: T-bit, E-bit
- List of neighbours

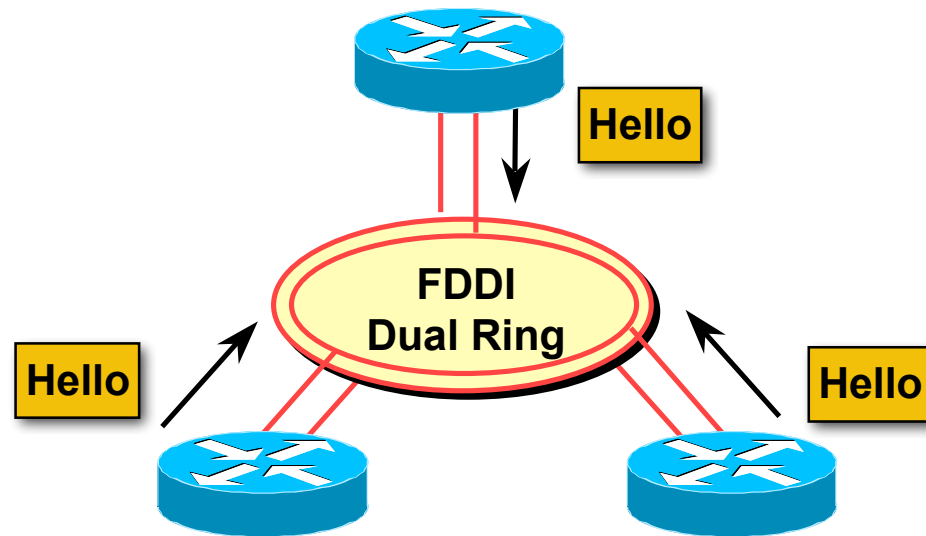

Designated Router

- There is **ONE** designated router per multi-access network
Generates network link advertisements
Assists in database synchronization

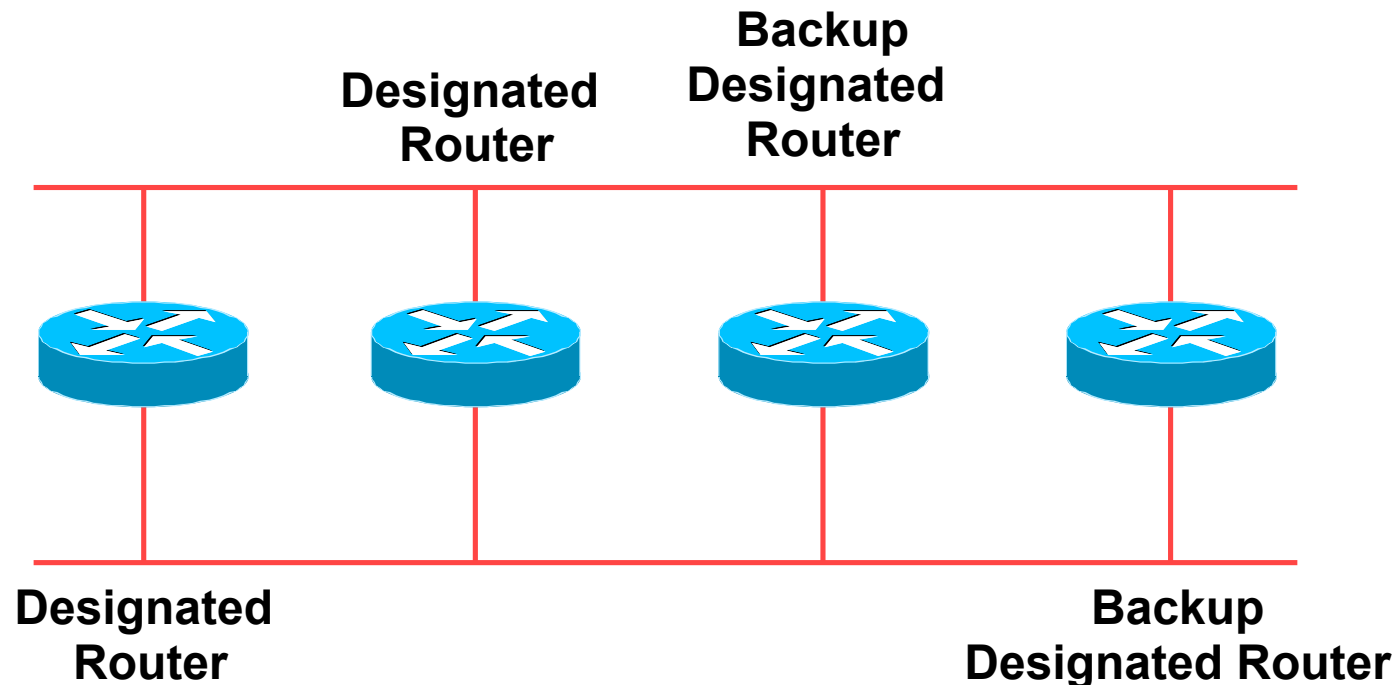

Designated Router by Priority

- **Configured priority (per interface)**
- **Else determined by highest router ID**

Router ID is the loopback interface address, if configured, otherwise the highest IP address

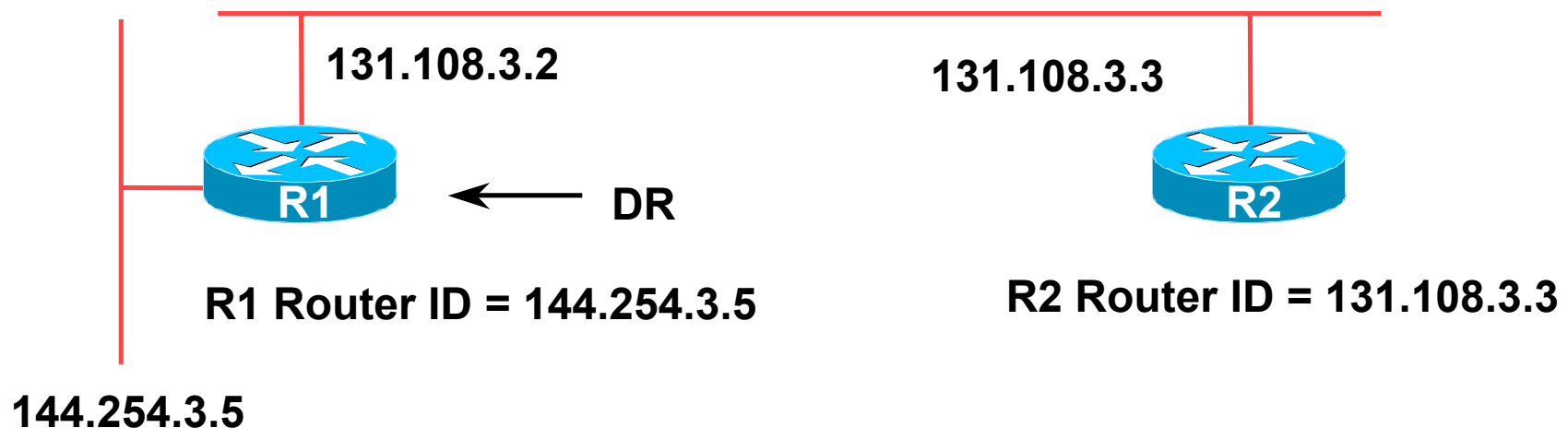

Neighbouring States

- **Full**

Routers are fully adjacent

Databases synchronised

Relationship to DR and BDR

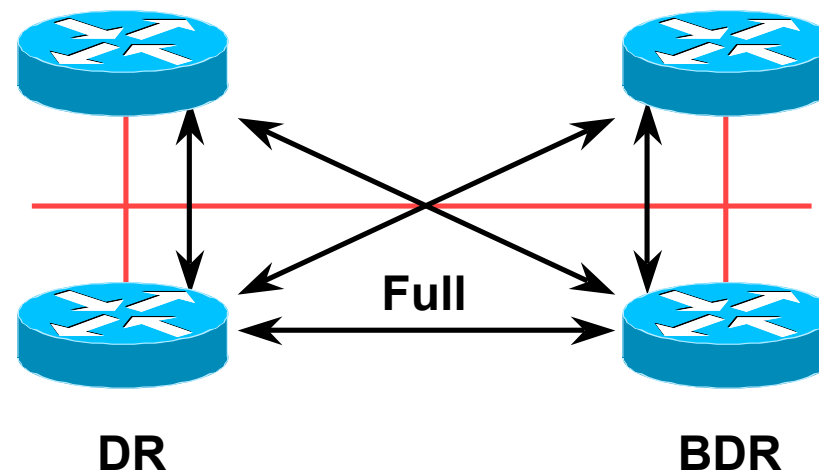

Neighbouring States

- **2-way**

Router sees itself in other Hello packets

DR selected from neighbours in state 2-way or greater

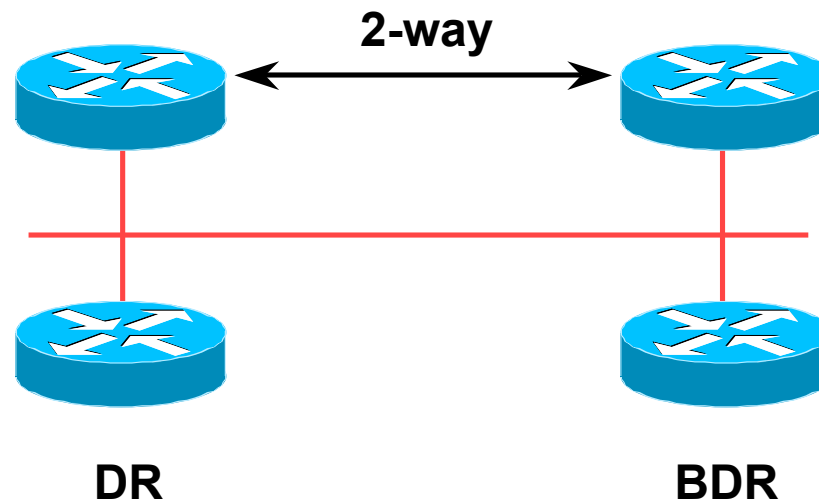

When to Become Adjacent

- **Underlying network is point to point**
- **Underlying network type is virtual link**
- **The router itself is the designated router**
- **The router itself is the backup designated router**
- **The neighbouring router is the designated router**
- **The neighbouring router is the backup designated router**

LSAs Propagate Along Adjacencies

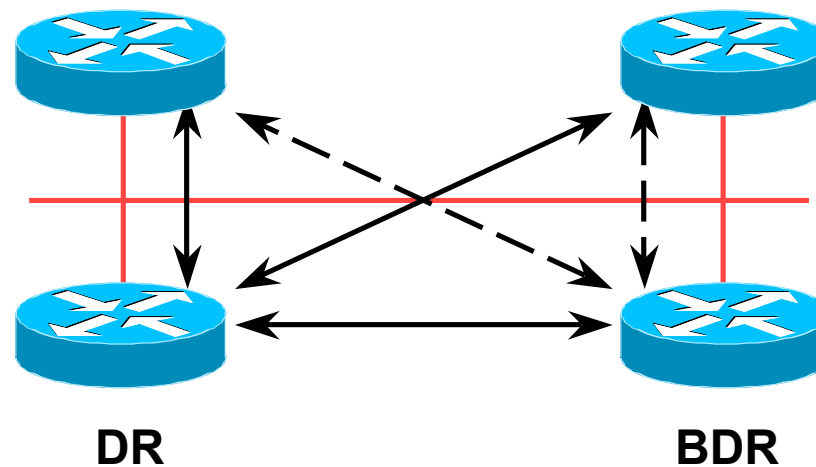

- **LSAs acknowledged along adjacencies**

Routing Protocol Packets

- **Share a common protocol header**
- **Routing protocol packets are sent with type of service (TOS) of 0**
- **Five types of OSPF routing protocol packets**
 - Hello – packet type 1**
 - Database description – packet type 2**
 - Link-state request – packet type 3**
 - Link-state update – packet type 4**
 - Link-state acknowledgement – packet type 5**

Different Types of LSAs

- **Four distinct type of LSAs**

Type 1 : Router LSA

Type 2 : Network LSA

Type 3 and 4: Summary LSA

Type 5 and 7: External LSA

Router LSA (Type 1)

- **Describes the state and cost of the router's links to the area**
- **All of the router's links in an area must be described in a single LSA**
- **Flooded throughout the particular area and no more**
- **Router indicates whether it is an ASBR, ABR, or end point of virtual link**

Network LSA (Type 2)

- **Generated for every transit broadcast and NBMA network**
- **Describes all the routers attached to the network**
- **Only the designated router originates this LSA**
- **Flooded throughout the area and no more**

Summary LSA (Type 3 and 4)

- **Describes the destination outside the area but still in the AS**
- **Flooded throughout a single area**
- **Originated by an ABR**
- **Only inter-area routes are advertised into the backbone**
- **Type 4 is the information about the ASBR**

External LSA (Type 5 and 7)

- **Defines routes to destination external to the AS**
- **Default route is also sent as external**
- **Two types of external LSA:**
 - E1: Consider the total cost up to the external destination**
 - E2: Considers only the cost of the outgoing interface to the external destination**
- **(Type 7 LSAs used to describe external LSA for one specific OSPF area type)**

No Summarisation

- Specific Link LSA advertised out of each area
- Link state changes propagated out of each area

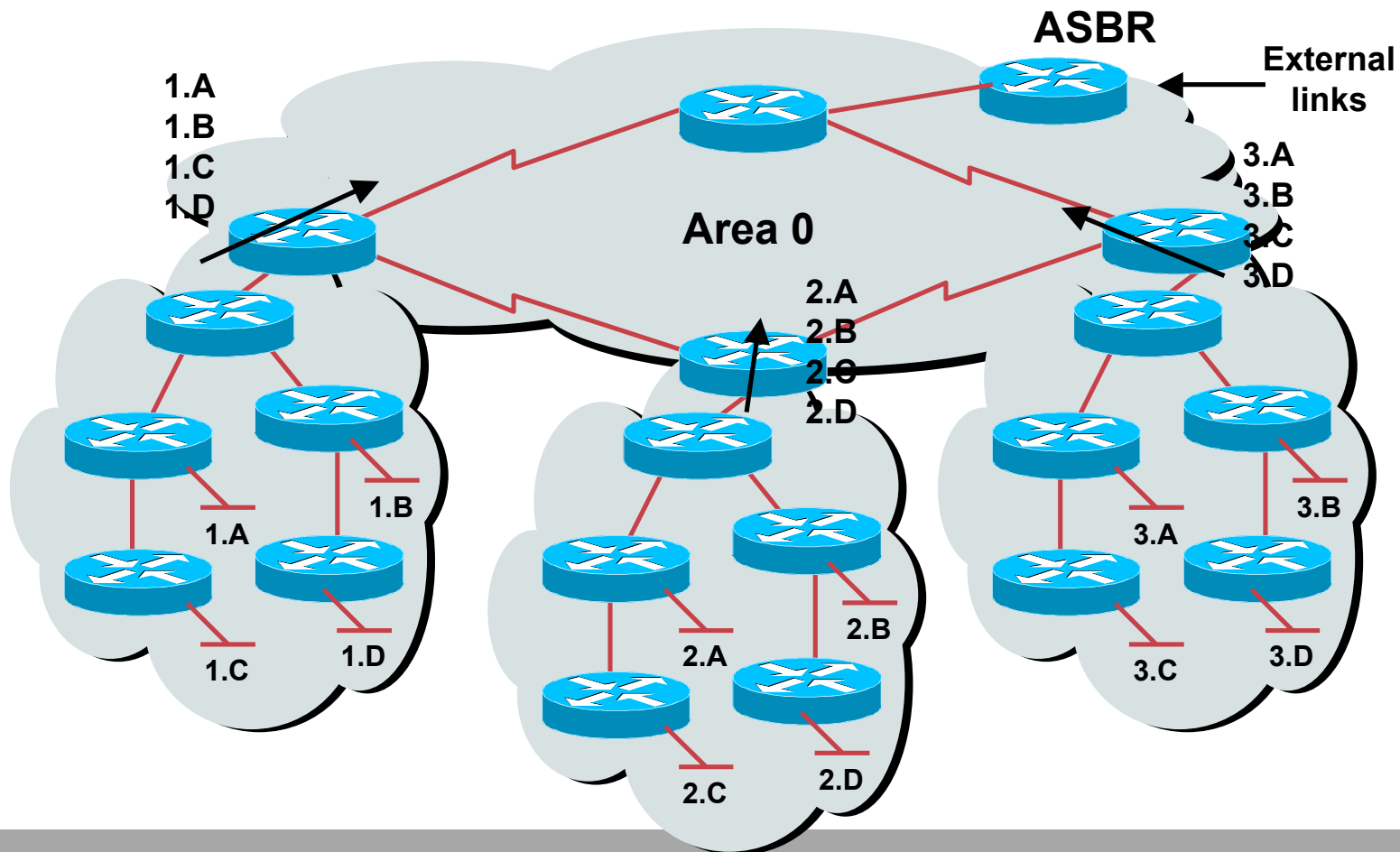

With Summarisation

- Only summary LSA advertised out of each area
- Link state changes do not propagate out of the area

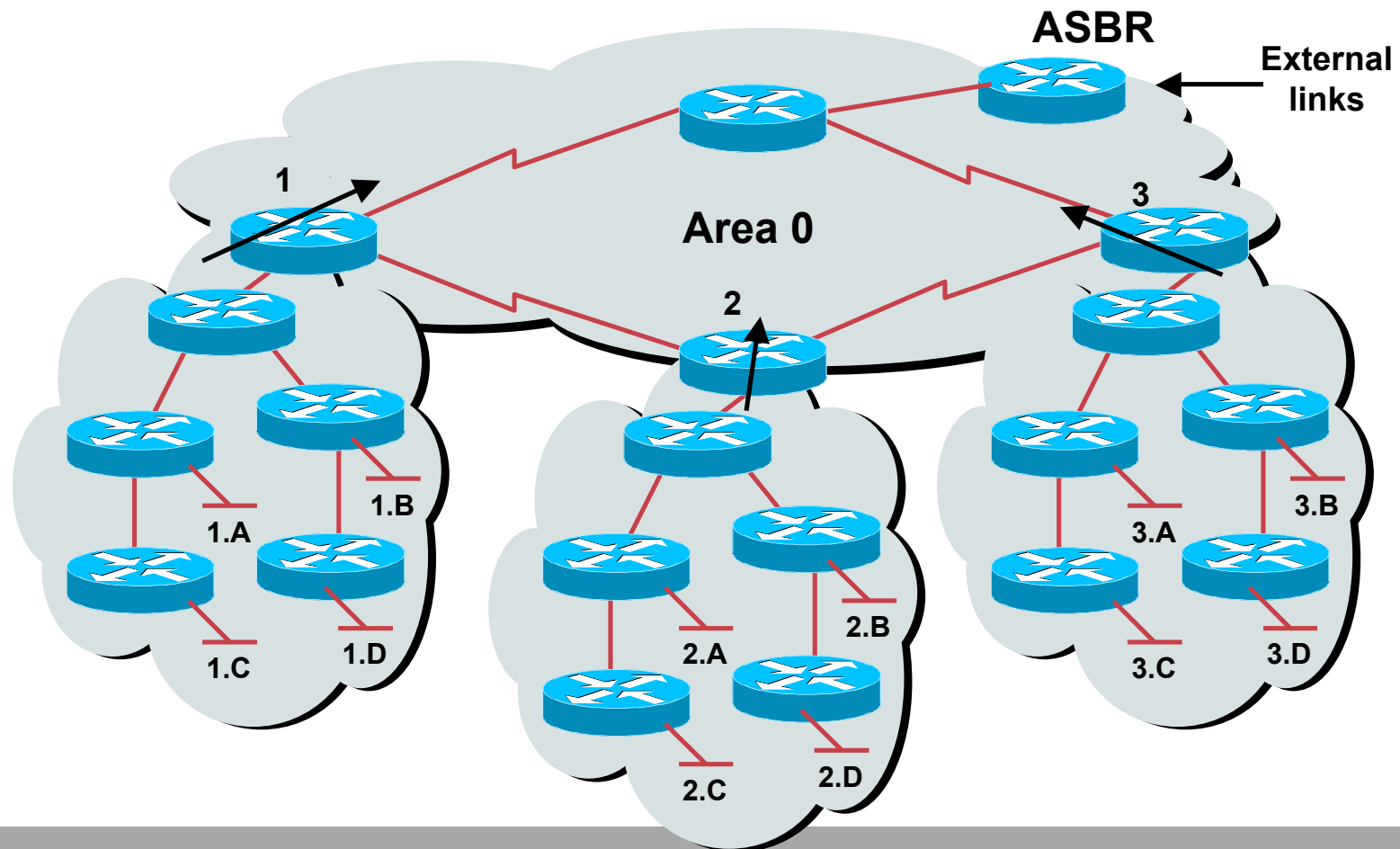

No Summarisation

- Specific Link LSA advertised in to each area
- Link state changes propagated in to each area

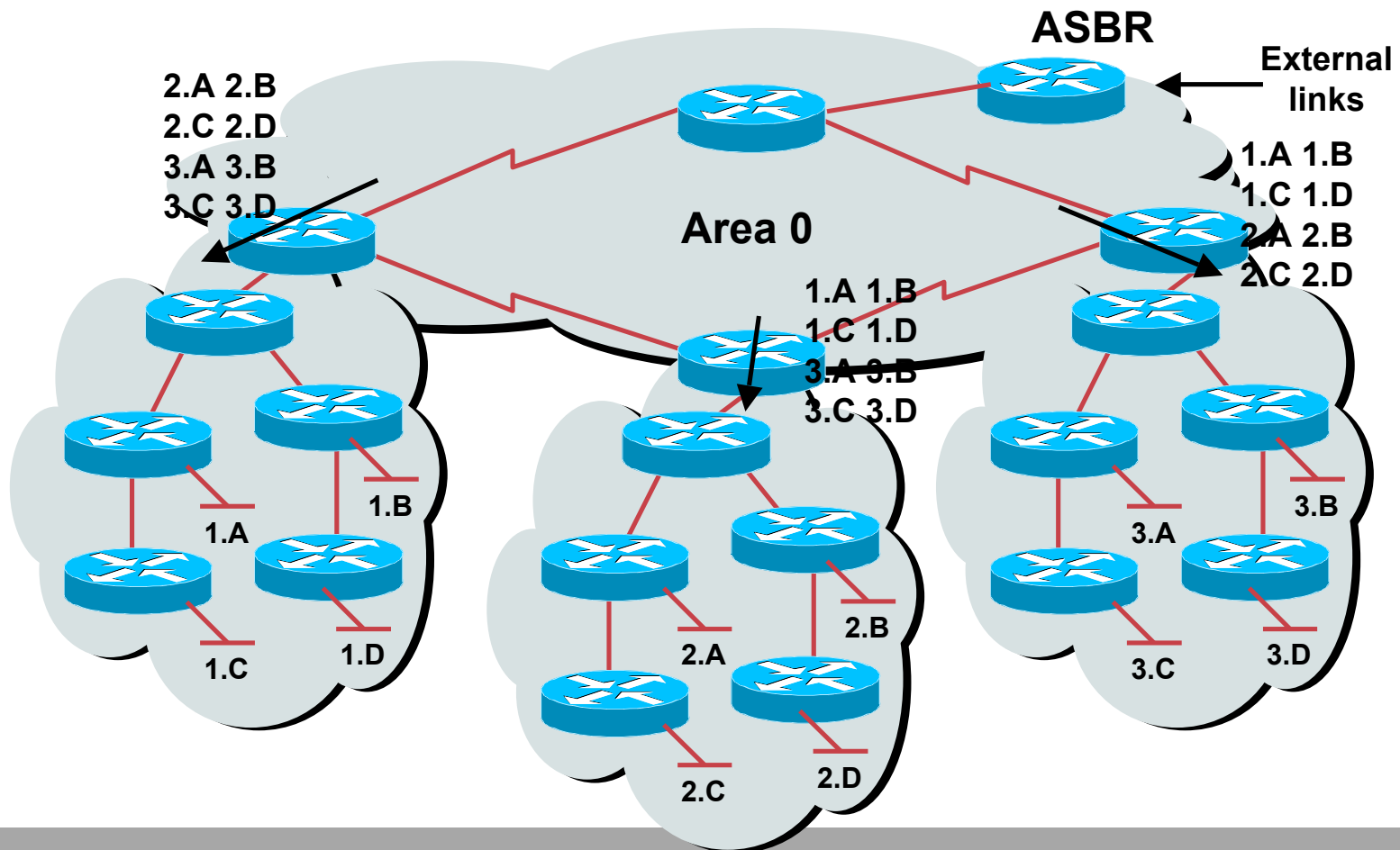

With Summarisation

- Only summary link LSA advertised in to each area
- Link state changes do not propagate in to each area

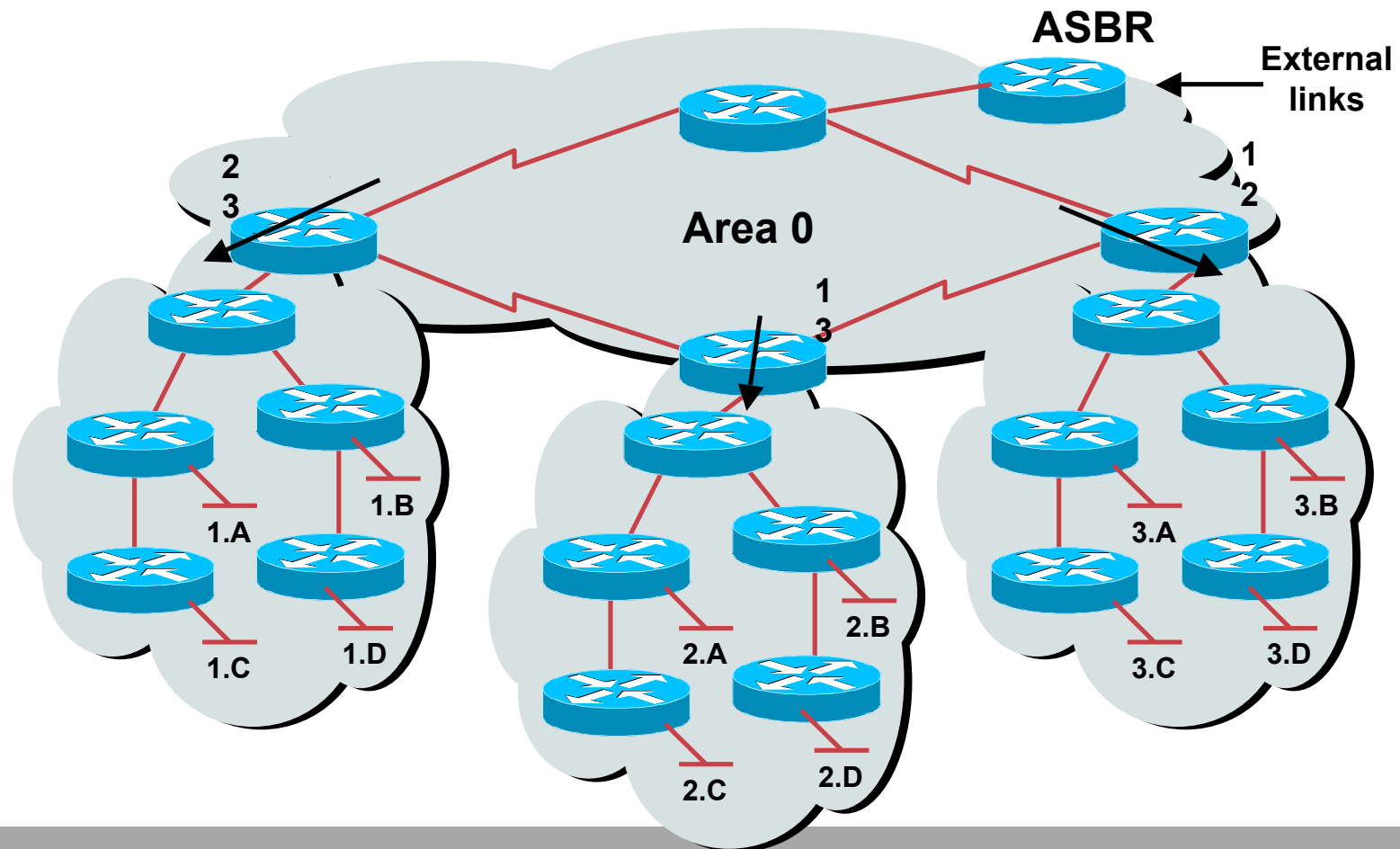

Types of Areas

- **Regular**
- **Stub**
- **Totally Stubby**
- **Not-So-Stubby**

Regular Area (Not a Stub)

- From Area 1's point of view, summary networks from other areas are injected as are external networks such as X.1

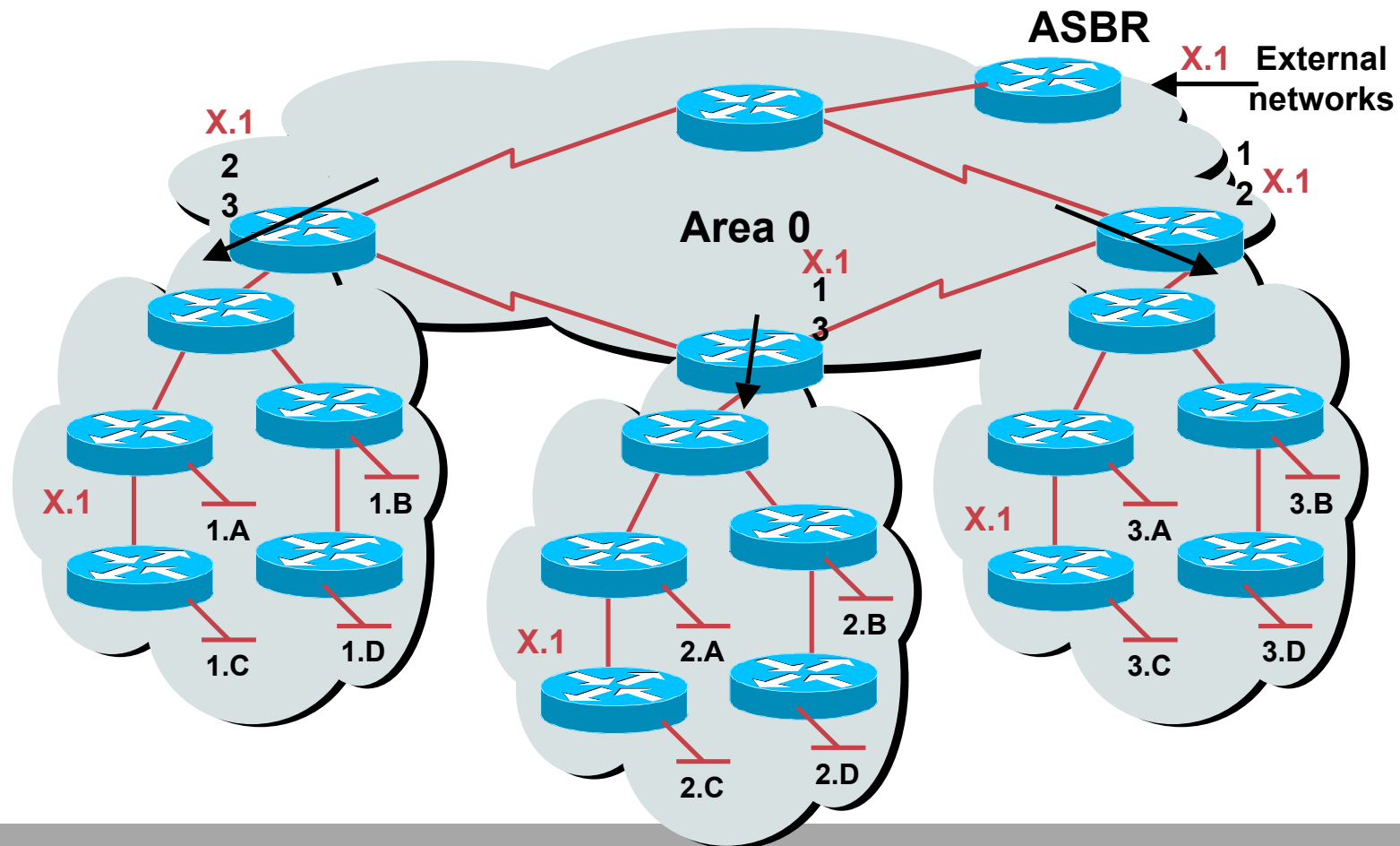

Normal Stub Area

- Summary networks, default route injected
- Command is `area x stub`

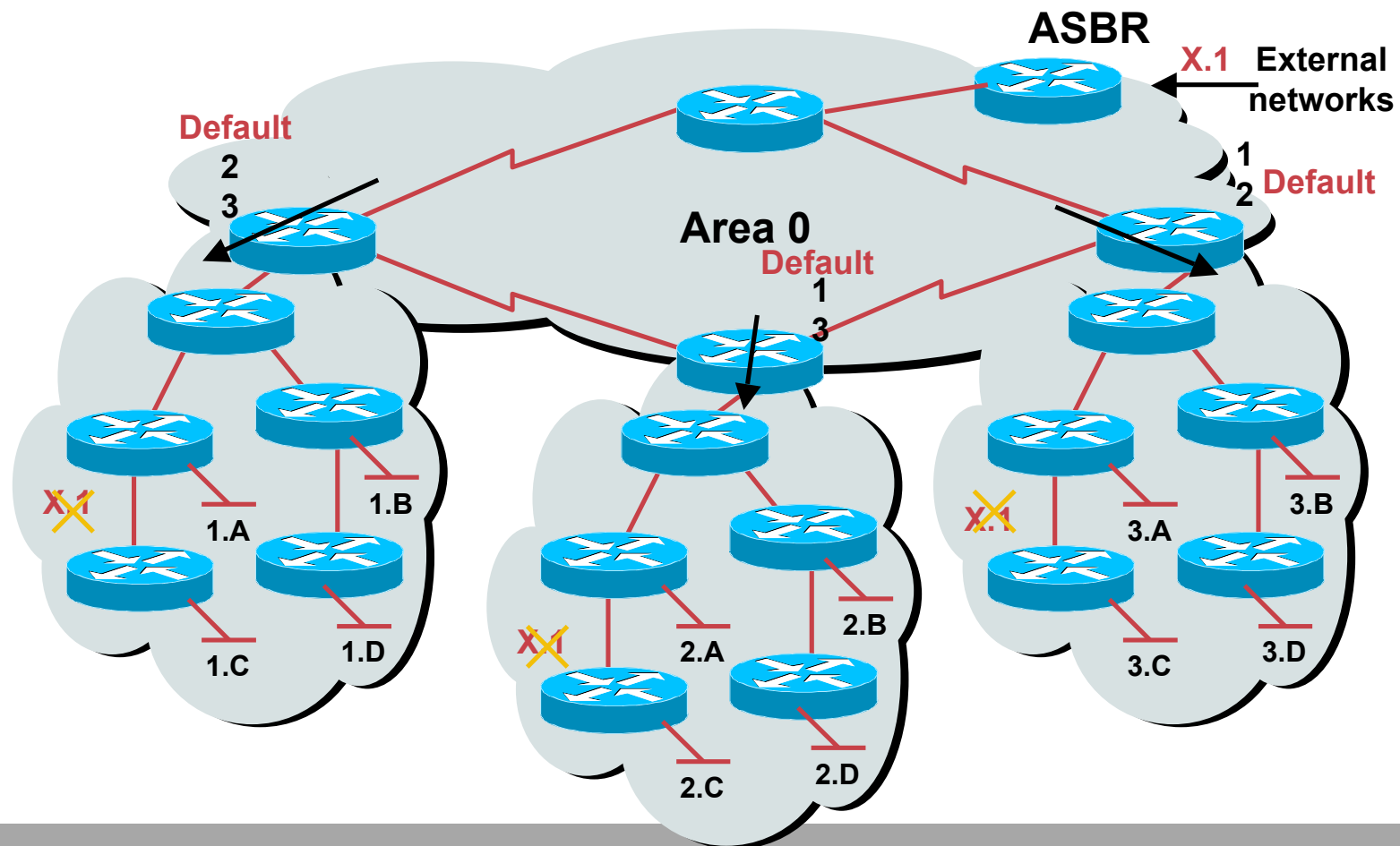

Not-So-Stubby Area

- Capable of importing routes in a limited fashion
- Type-7 LSA's carry external information within an NSSA
- NSSA Border routers translate selected type-7 LSAs into type-5 external network LSAs

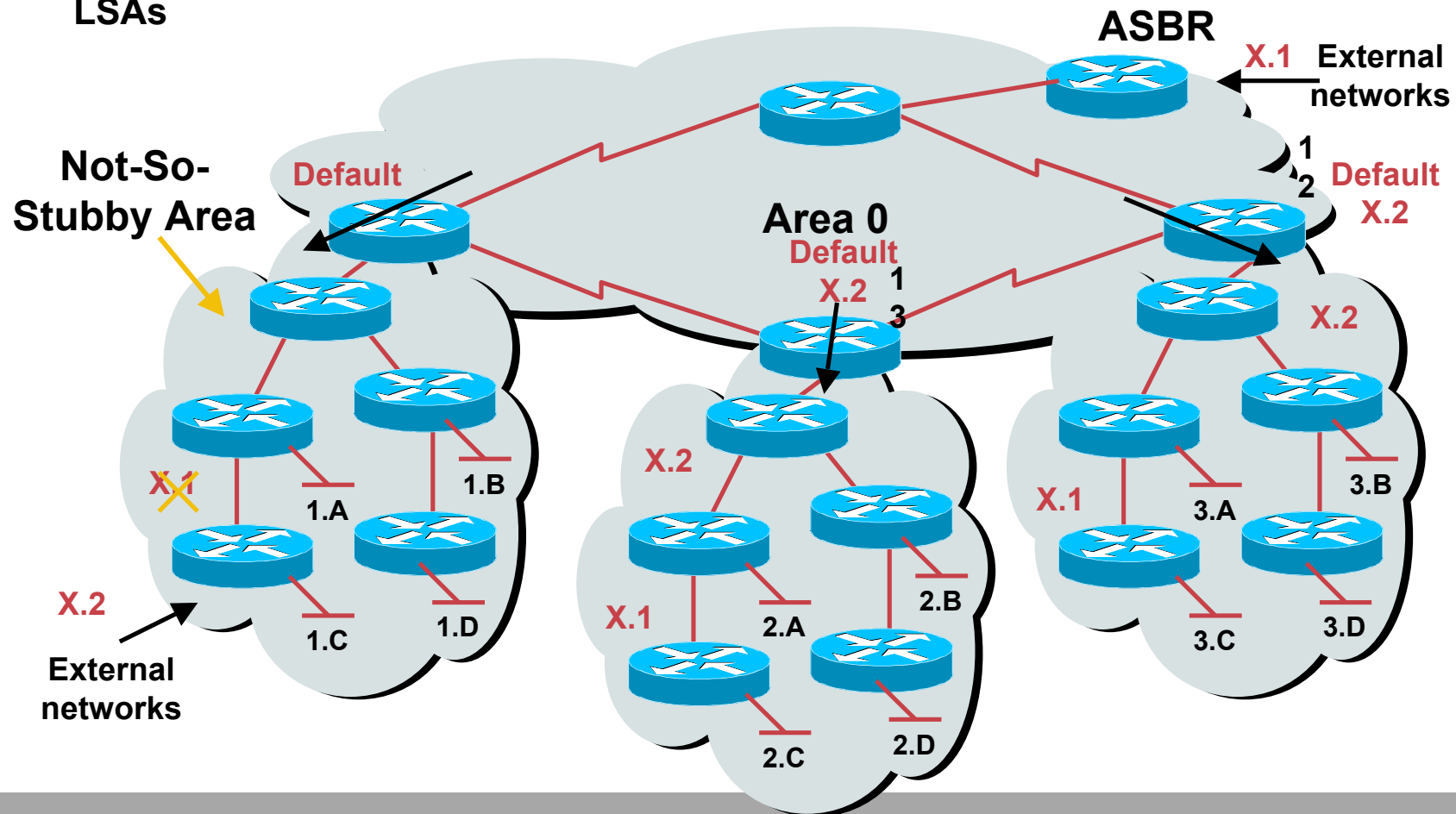

Addressing for Areas

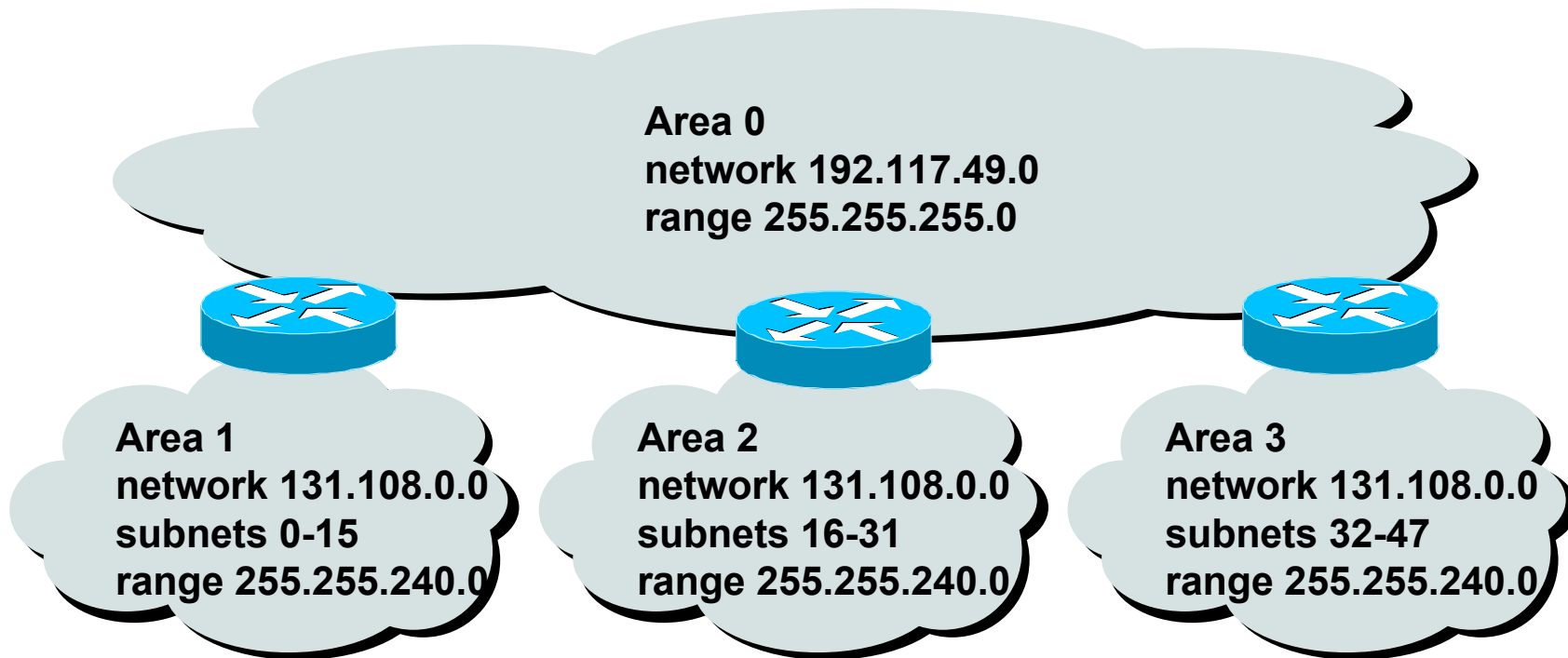

Assign contiguous ranges of subnets per area to facilitate summarisation

Summary

- **Scalable OSPF Network Design**

- Area hierarchy**

- Stub areas**

- Contiguous addressing**

- Route summarisation**



Introduction to OSPF

ISP/IXP Workshops