



Introduction to OSPF

ISP/IXP Workshops

OSPF

- Open Shortest Path First
- Link state or SPF technology
- Developed by OSPF working group of IETF (RFC 1247)
- OSPFv2 standard described in RFC2328
- Designed for:
 - TCP/IP environment
 - Fast convergence
 - Variable-length subnet masks
 - Discontiguous subnets
 - Incremental updates
 - Route authentication
- Runs on IP, Protocol 89

Link State

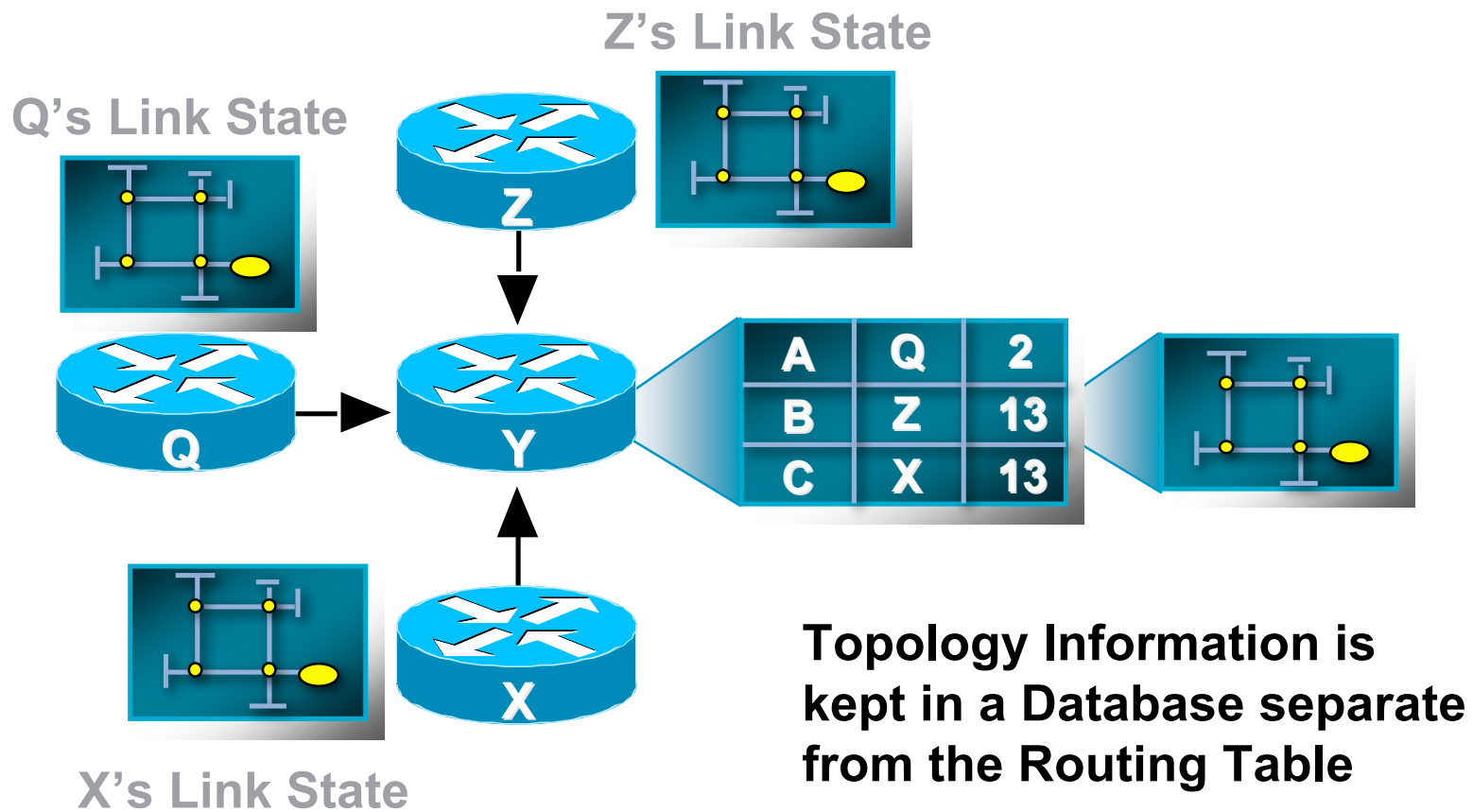

Link State Routing

- Neighbour discovery
- Constructing a Link State Packet (LSP)
- Distribute the LSP
 - (Link State Announcement – LSA)
- Compute routes
- On network failure
 - New LSPs flooded
 - All routers recompute routing table

Low Bandwidth Utilisation

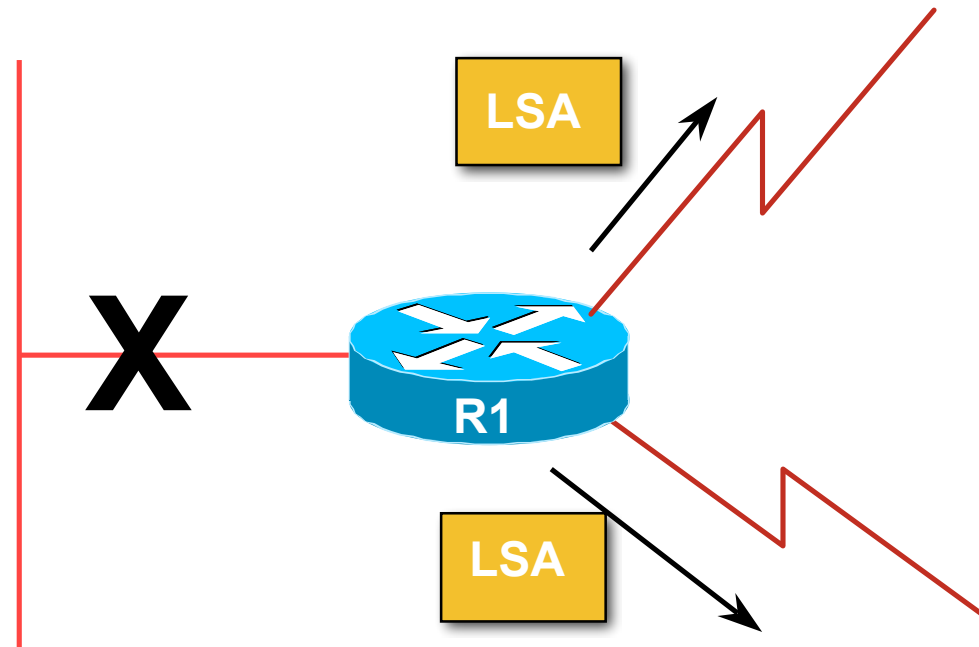

- Only changes propagated
- Uses multicast on multi-access broadcast networks

Fast Convergence

- Detection Plus LSA/SPF
Known as the Dijkstra Algorithm

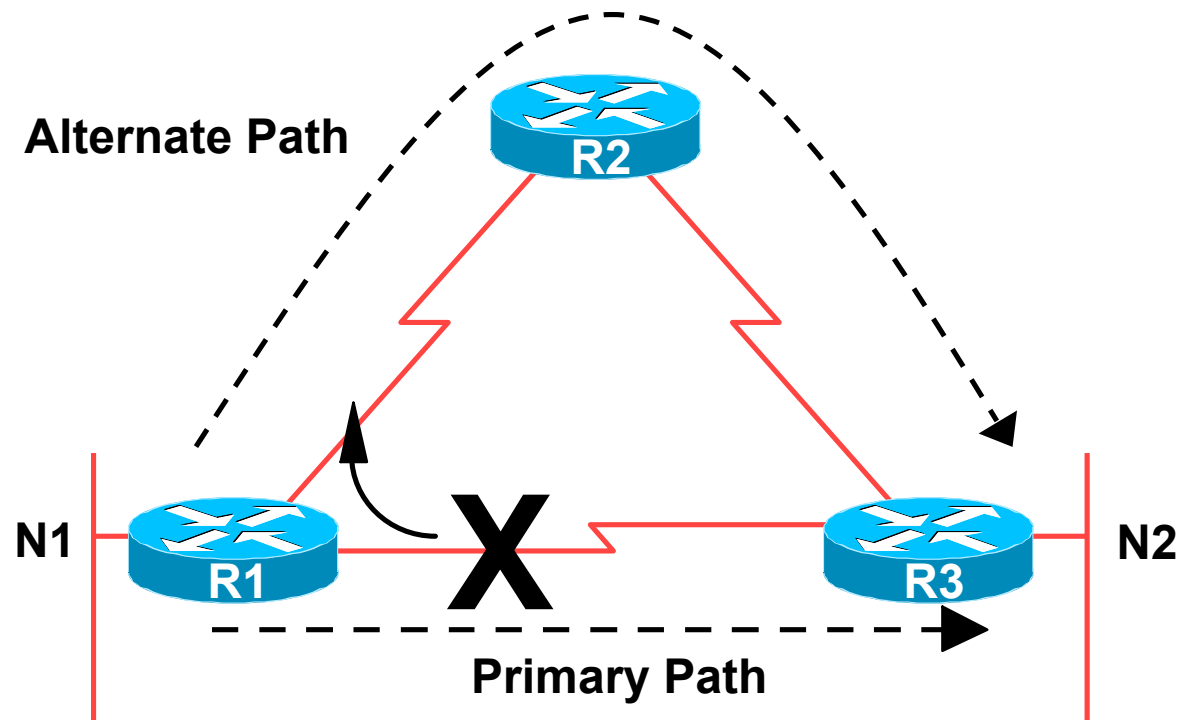

Fast Convergence

- Finding a new route

- LSA flooded throughout area

- Acknowledgement based

- Topology database synchronised

- Each router derives routing table to destination network

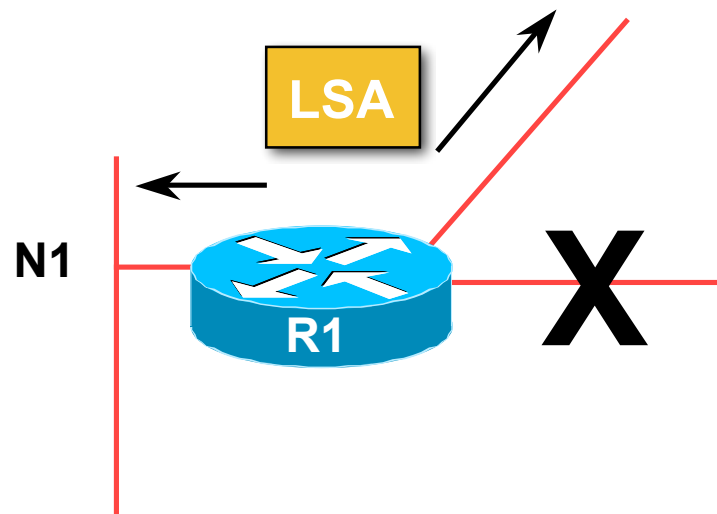

OSPF Areas

- Area is a group of contiguous hosts and networks
 - Reduces routing traffic
- Per area topology database
 - Invisible outside the area
- Backbone area **MUST** be contiguous
 - All other areas must be connected to the backbone

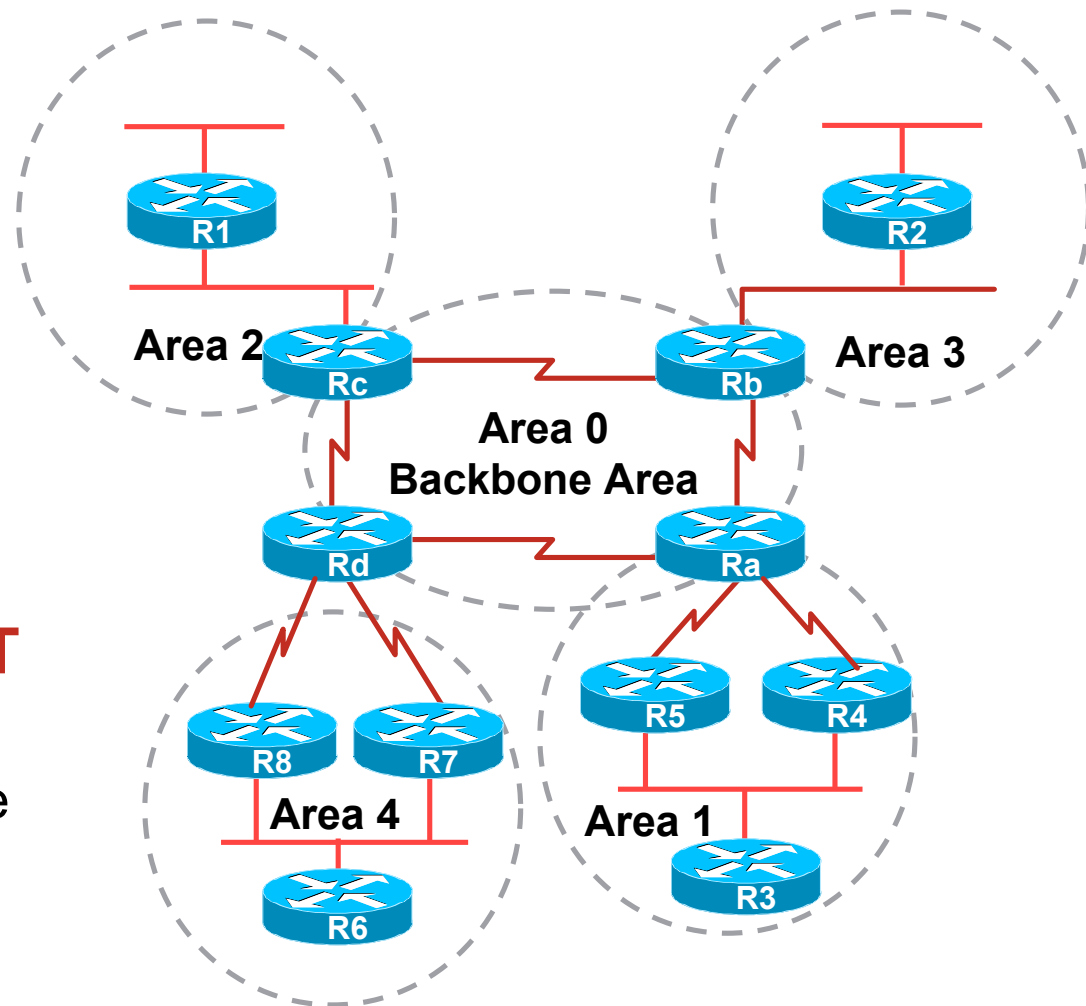

Virtual Links between OSPF Areas

- Virtual Link is used when it is not possible to physically connect the area to the backbone

- ISPs avoid designs which require virtual links**

Increases complexity

Decreases reliability and scalability

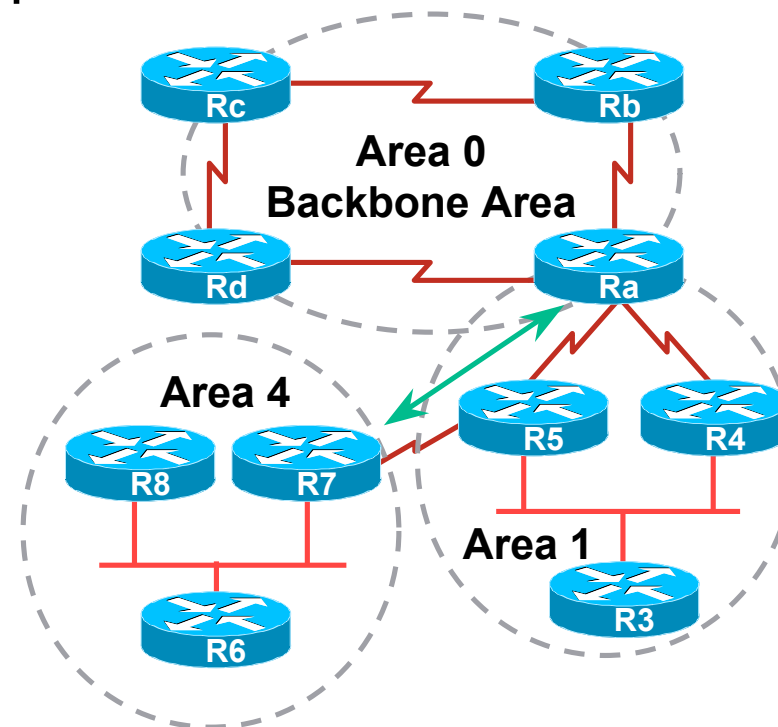

Classification of Routers

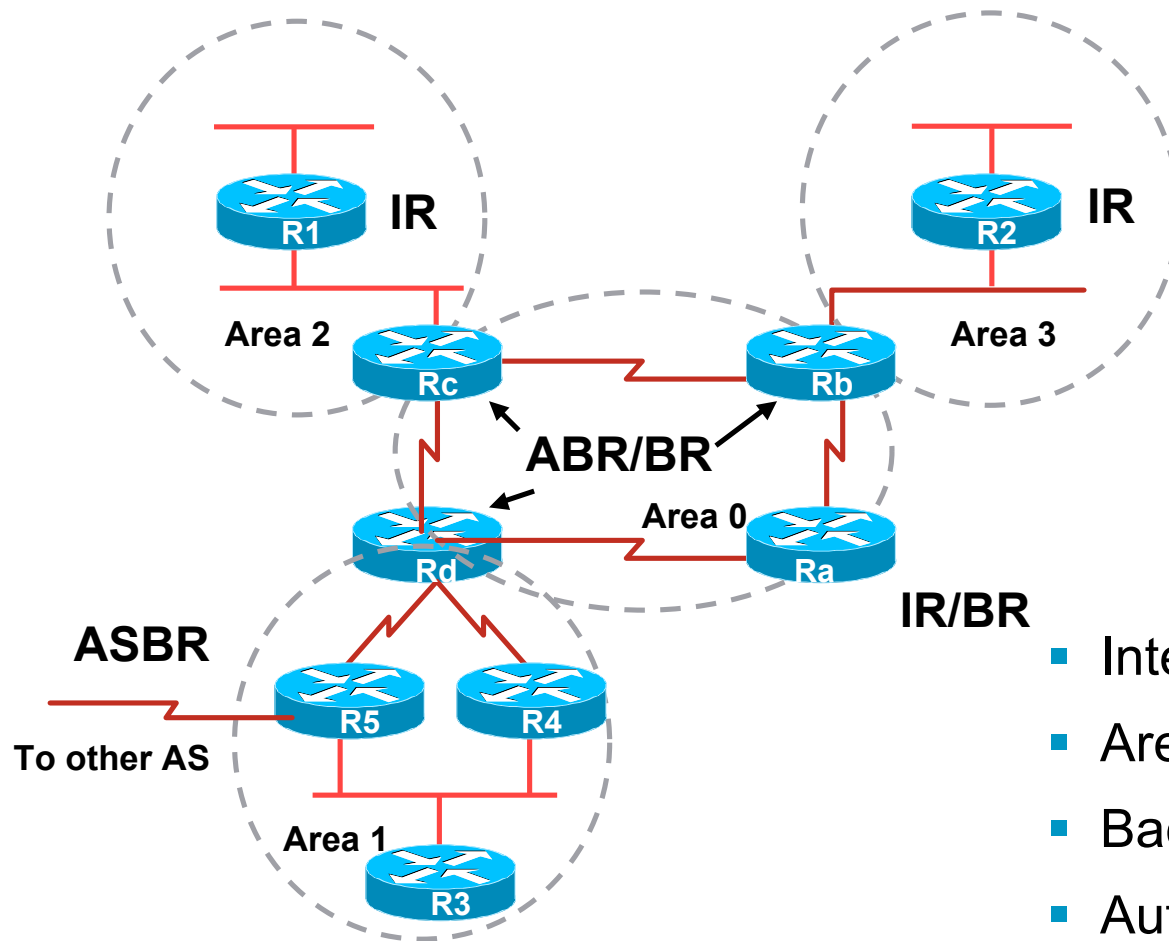

- Internal Router (IR)
- Area Border Router (ABR)
- Backbone Router (BR)
- Autonomous System Border Router (ASBR)

External Routes

- Prefixes which are redistributed into OSPF from other protocols
- Flooded unaltered throughout the AS
 - Recommendation: Avoid redistribution!!**
- OSPF supports two types of external metrics
 - Type 1 external metrics
 - Type 2 external metrics (IOS default)

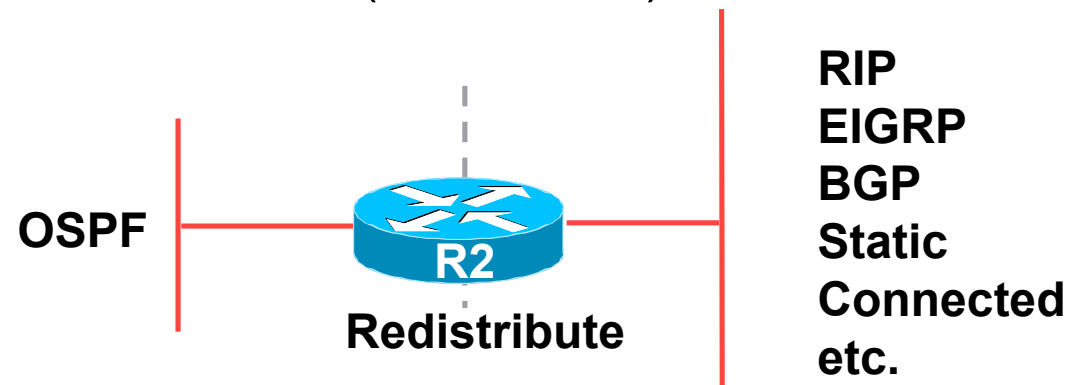

External Routes

- Type 1 external metric: metrics are added to the summarised internal link cost

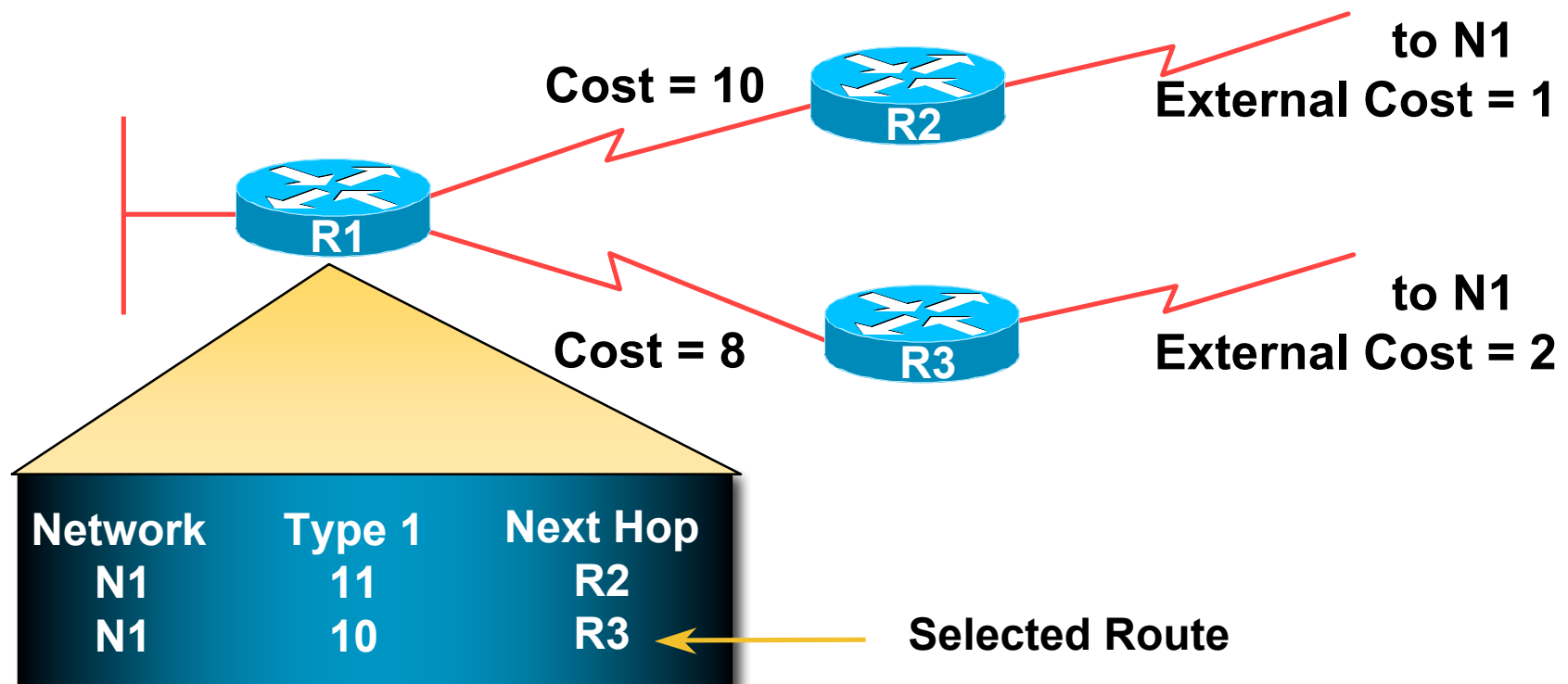

External Routes

- Type 2 external metric: metrics are compared without adding to the internal link cost

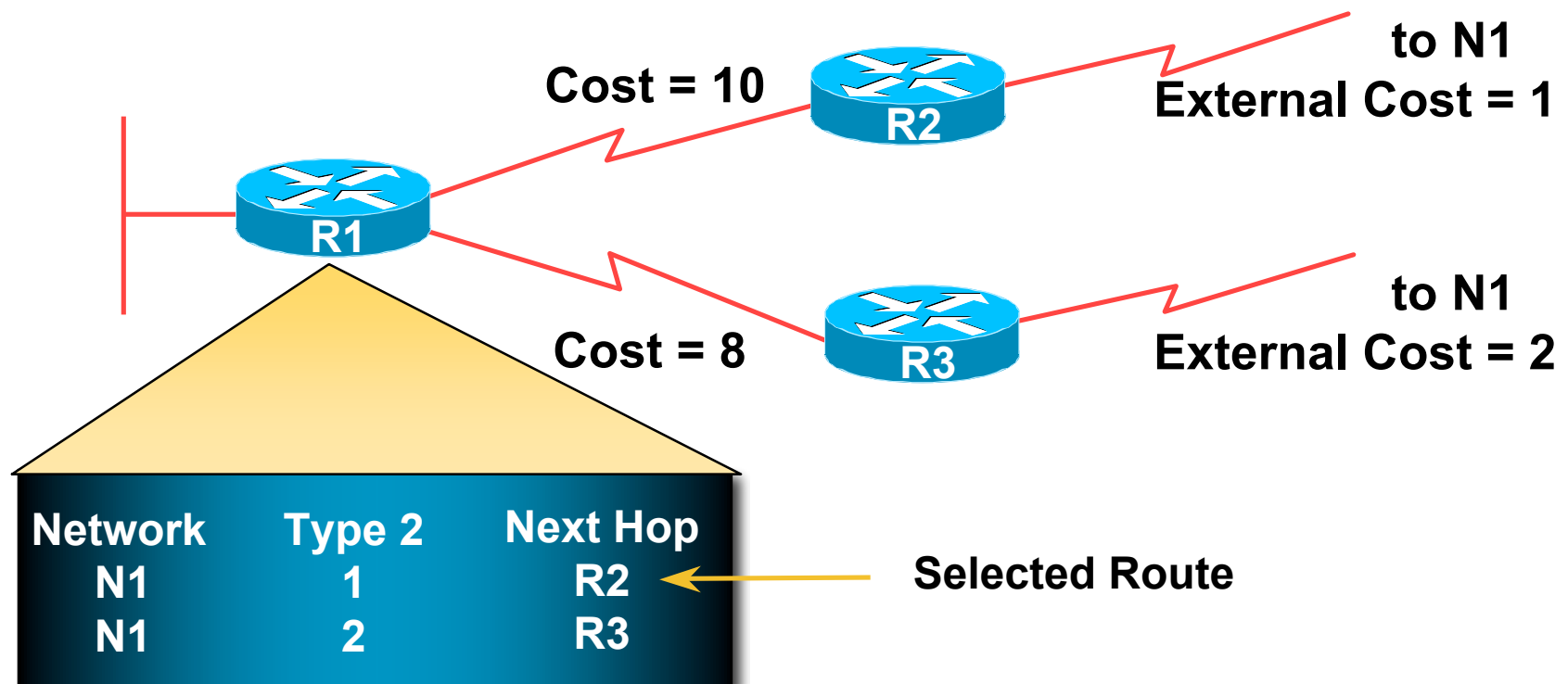

Topology/Link State Database

- A router has a separate LS database for each area to which it belongs
- All routers belonging to the same area have identical database
- SPF calculation is performed separately for each area
- LSA flooding is bounded by area
- Recommendation:
 - Limit the number of areas a router participates in!!
 - 1 to 3 is fine (typical ISP design)
 - >3 can weigh down the CPU depending on the area topology complexity

The Hello Protocol

- Responsible for establishing and maintaining neighbour relationships
- Elects designated router on multi-access networks

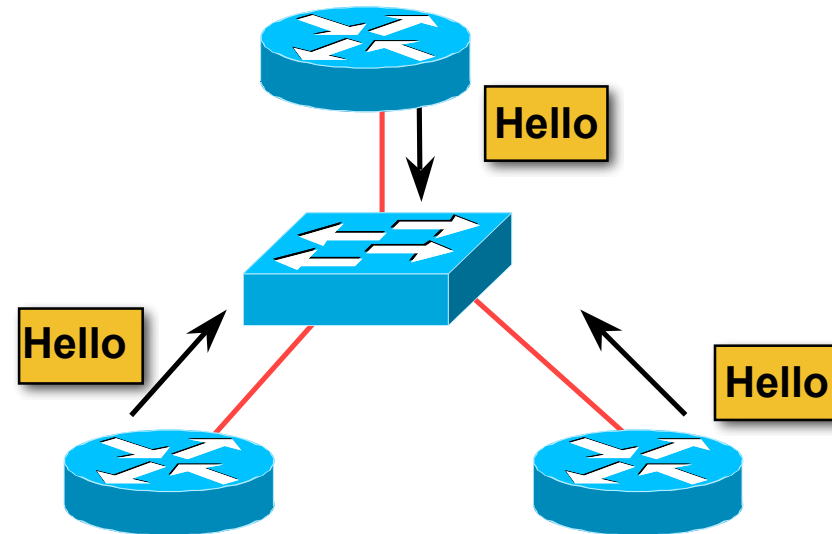

The Hello Packet

- Contains:
 - Router priority
 - Hello interval
 - Router dead interval
 - Network mask
 - List of neighbours
 - DR and BDR
 - Options: E-bit, MC-bit,....
(see A.2 of RFC2328)

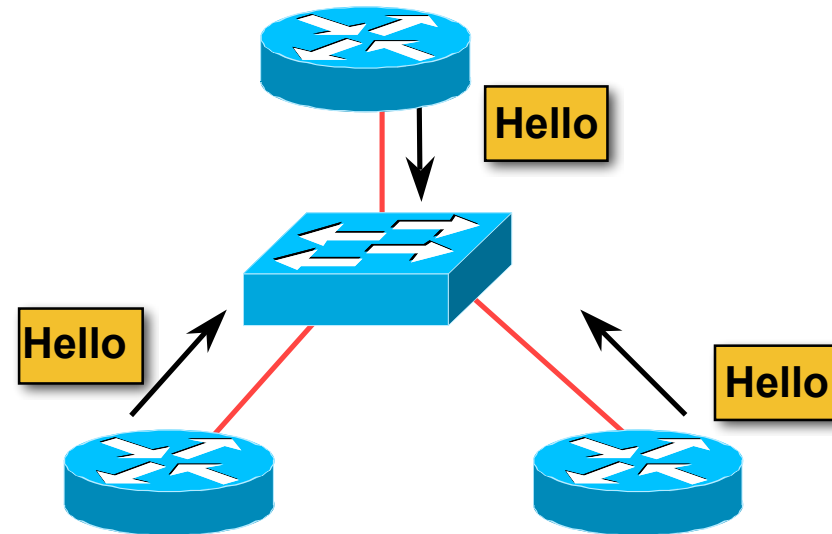

Designated Router

- There is ONE designated router per multi-access network
Generates network link advertisements
Assists in database synchronization

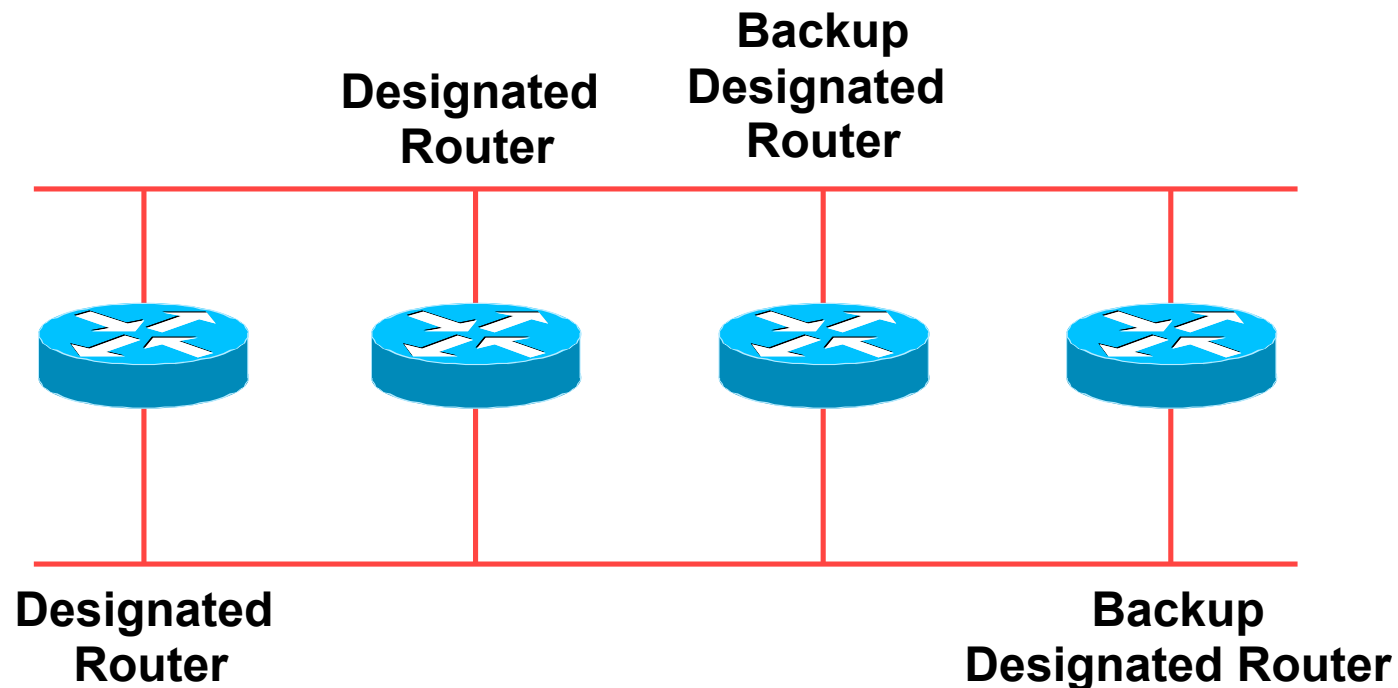

Designated Router by Priority

- Configured priority (per interface)
 - **ISPs configure high priority on the routers they want as DR/BDR**
- Else determined by highest router ID
 - Router ID is 32 bit integer
 - Derived from the loopback interface address, if configured, otherwise the highest IP address

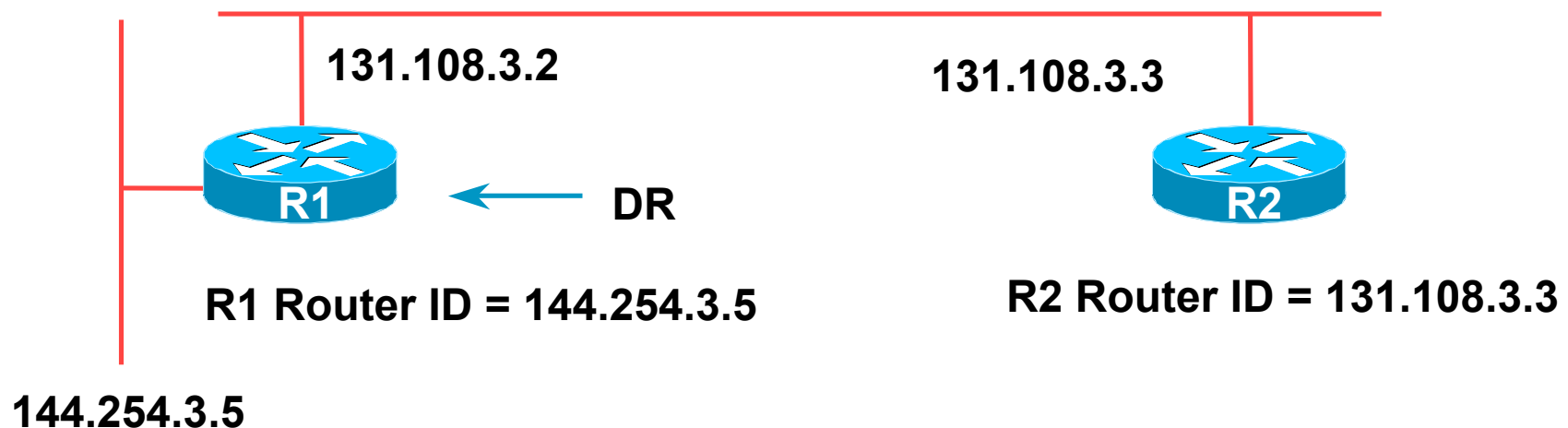

Neighbouring States

- Full

Routers are fully adjacent

Databases synchronised

Relationship to DR and BDR

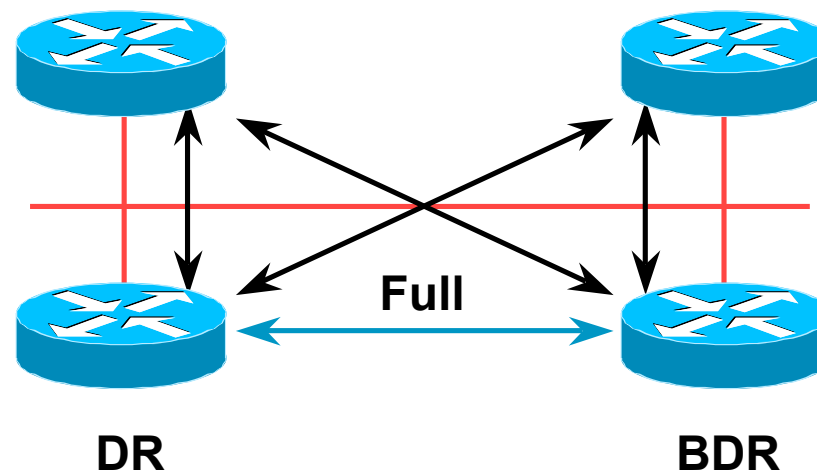

Neighbouring States

- 2-way

Router sees itself in other Hello packets

DR selected from neighbours in state 2-way or greater

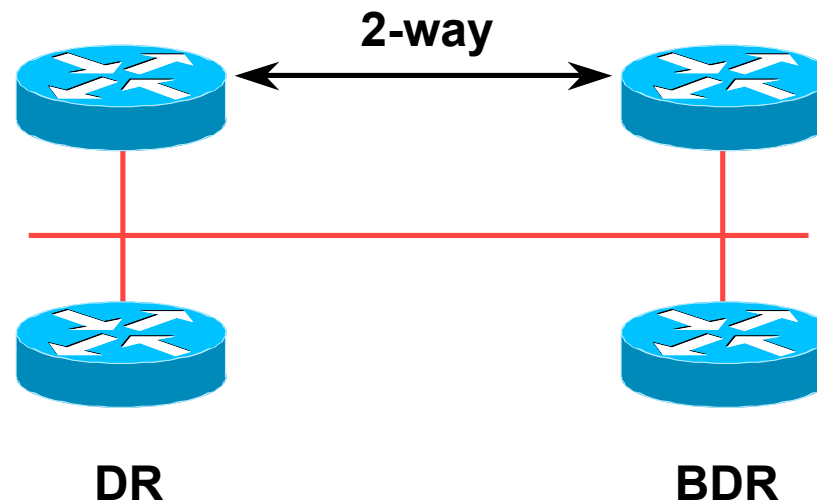

When to Become Adjacent

- Underlying network is point to point
- Underlying network type is virtual link
- The router itself is the designated router or the backup designated router
- The neighbouring router is the designated router or the backup designated router

LSAs Propagate Along Adjacencies

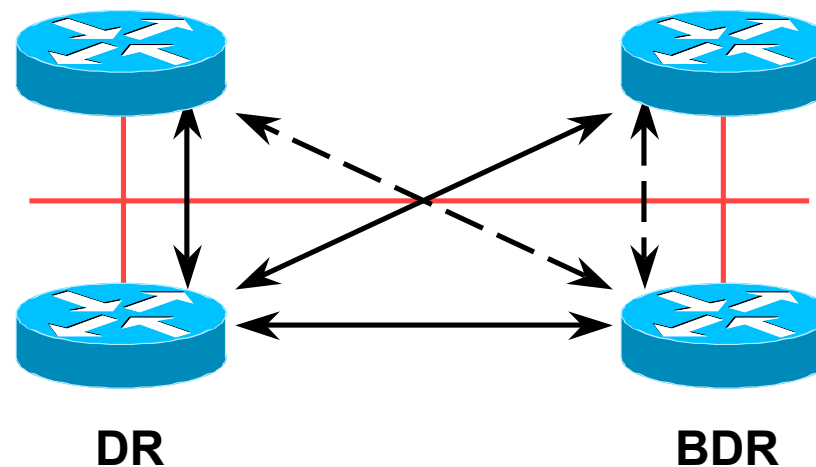

- LSAs acknowledged along adjacencies

Broadcast Networks

- IP Multicast used for Sending and Receiving Updates

 - All routers must accept packets sent to AllSPFRouters (224.0.0.5)

 - All DR and BDR routers must accept packets sent to AllDRouters (224.0.0.6)

- Hello packets sent to AllSPFRouters (Unicast on point-to-point and virtual links)

Routing Protocol Packets

- Share a common protocol header
- Routing protocol packets are sent with type of service (TOS) of 0
- Five types of OSPF routing protocol packets
 - Hello – packet type 1
 - Database description – packet type 2
 - Link-state request – packet type 3
 - Link-state update – packet type 4
 - Link-state acknowledgement – packet type 5

Different Types of LSAs

- Six distinct type of LSAs

Type 1 :	Router LSA
Type 2 :	Network LSA
Type 3 & 4:	Summary LSA
Type 5 & 7:	External LSA (Type 7 is for NSSA)
Type 6:	Group membership LSA
Type 9, 10 & 11:	Opaque LSA (9: Link-Local, 10: Area)

Router LSA (Type 1)

- Describes the state and cost of the router's links to the area
- All of the router's links in an area must be described in a single LSA
- Flooded throughout the particular area and no more
- Router indicates whether it is an ASBR, ABR, or end point of virtual link

Network LSA (Type 2)

- Generated for every transit broadcast and NBMA network
- Describes all the routers attached to the network
- Only the designated router originates this LSA
- Flooded throughout the area and no more

Summary LSA (Type 3 and 4)

- Describes the destination outside the area but still in the AS
- Flooded throughout a single area
- Originated by an ABR
- Only inter-area routes are advertised into the backbone
- Type 4 is the information about the ASBR

External LSA (Type 5 and 7)

- Defines routes to destination external to the AS
- Default route is also sent as external
- Two types of external LSA:
 - E1: Consider the total cost up to the external destination
 - E2: Considers only the cost of the outgoing interface to the external destination
- (Type 7 LSAs used to describe external LSA for one specific OSPF area type)

Inter-Area Route Summarisation

- Prefix or all subnets
- Prefix or all networks
- 'Area range' command

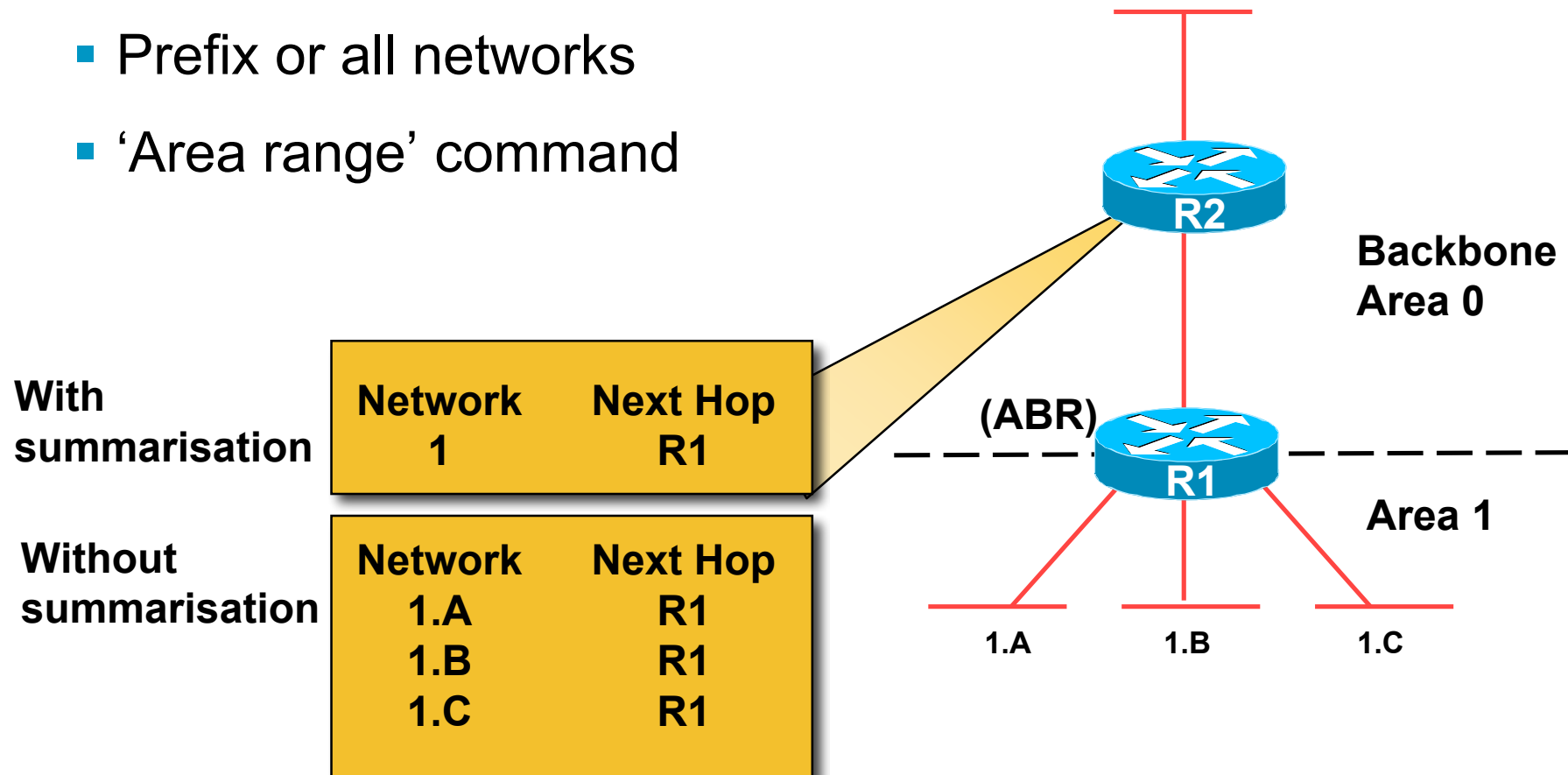

No Summarisation

- Specific Link LSA advertised out of each area
- Link state changes propagated out of each area

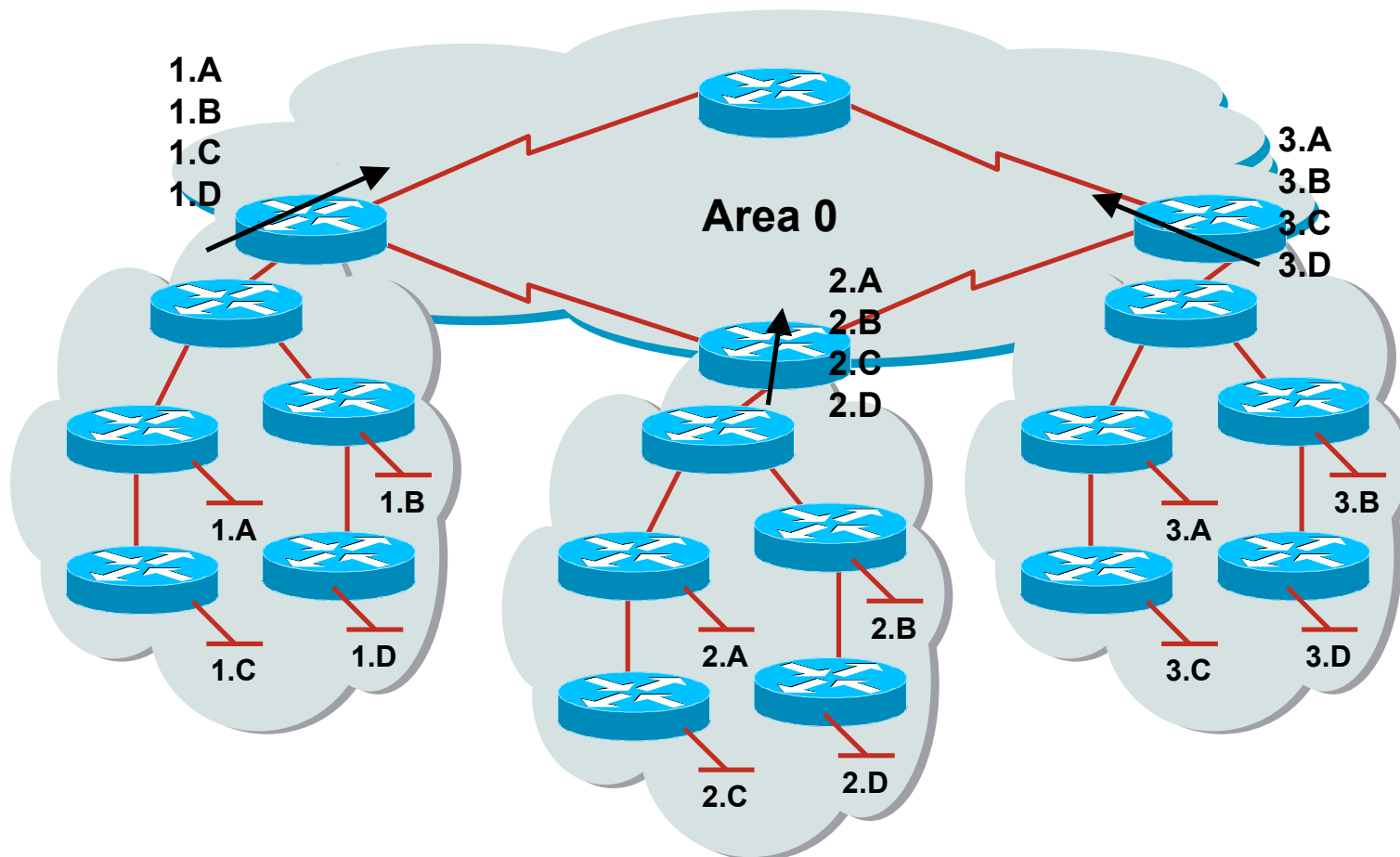

With Summarisation

- Only summary LSA advertised out of each area
- Link state changes do not propagate out of the area

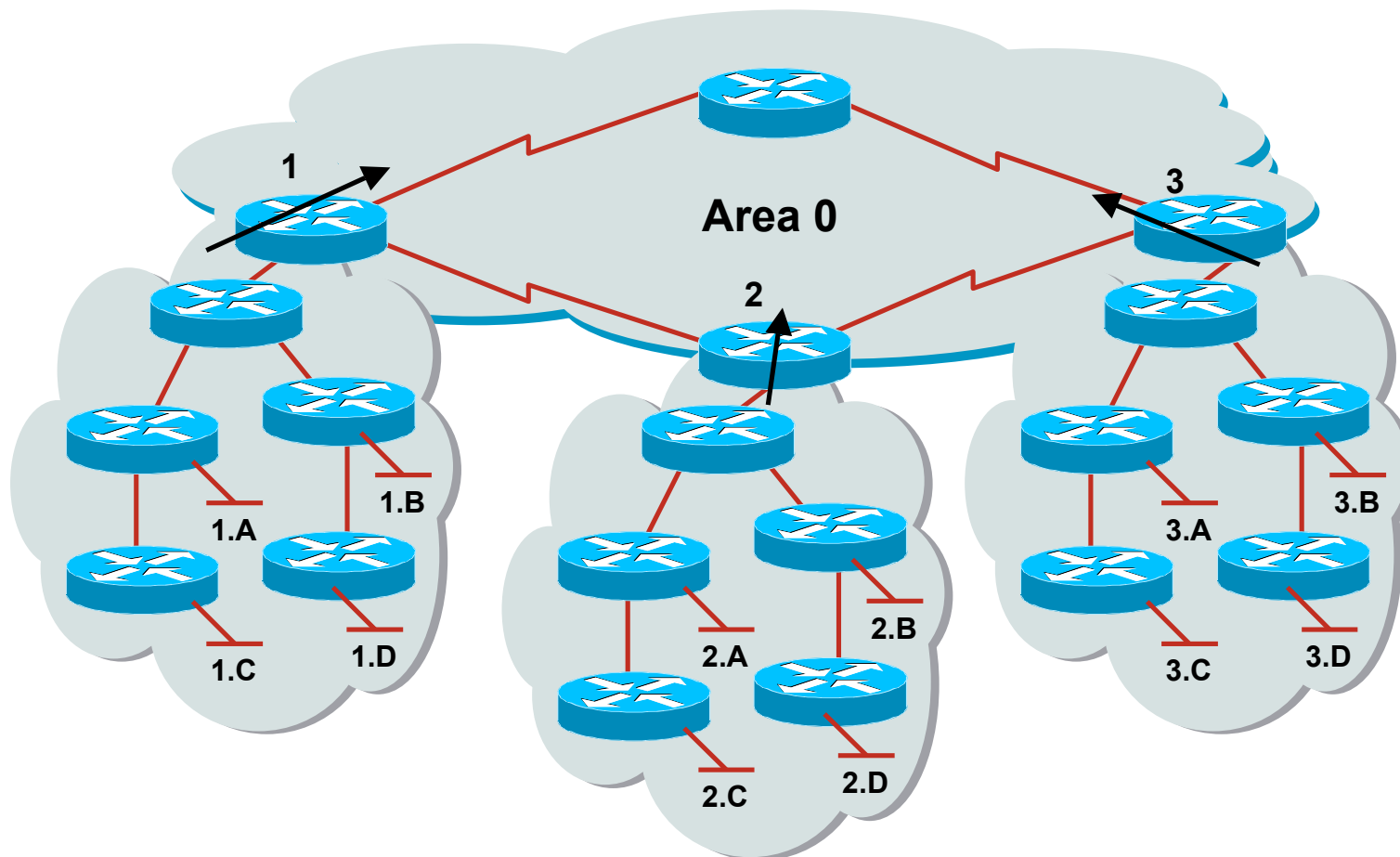

No Summarisation

- Specific Link LSA advertised in to each area
- Link state changes propagated in to each area

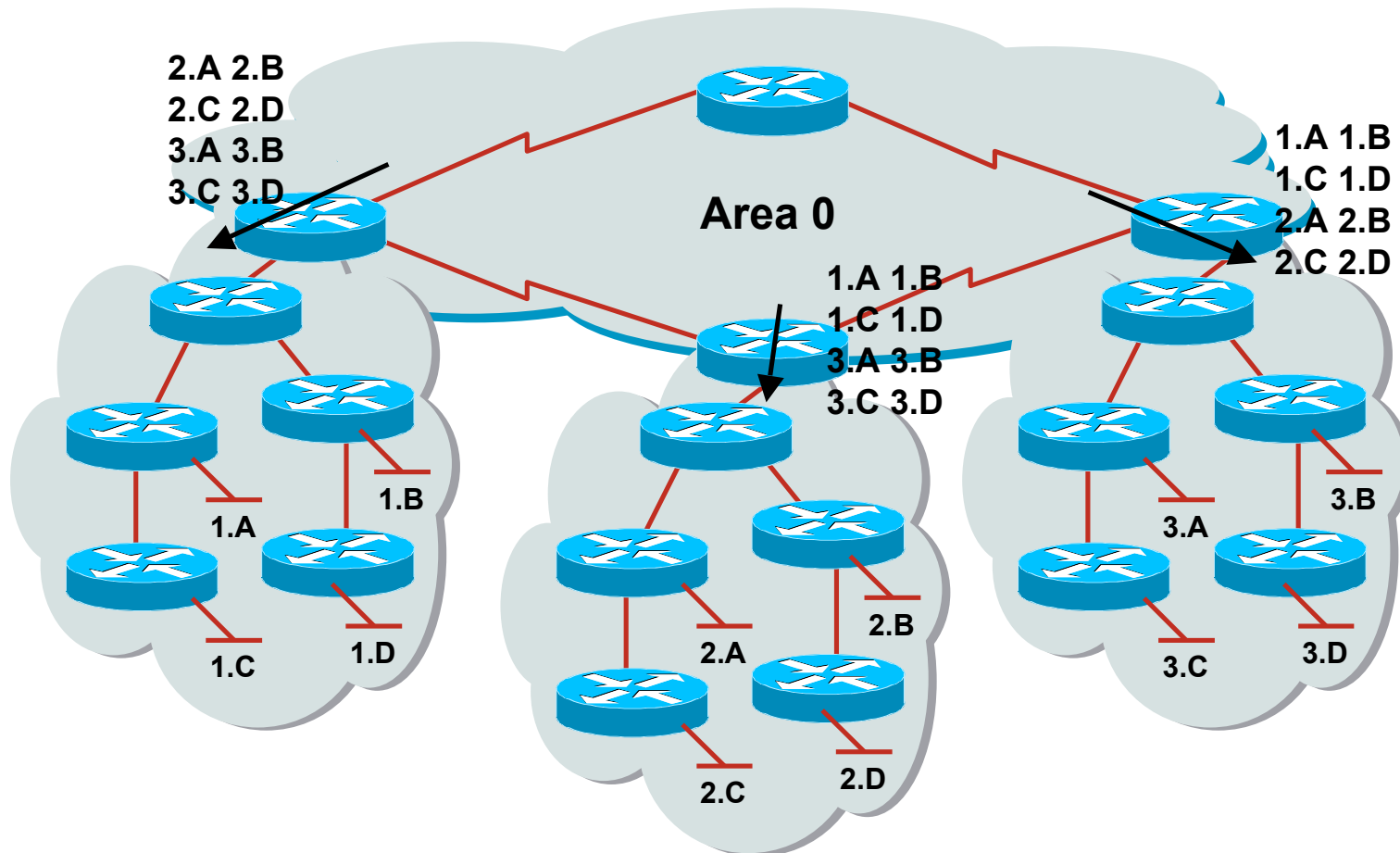

With Summarisation

- Only summary link LSA advertised in to each area
- Link state changes do not propagate in to each area

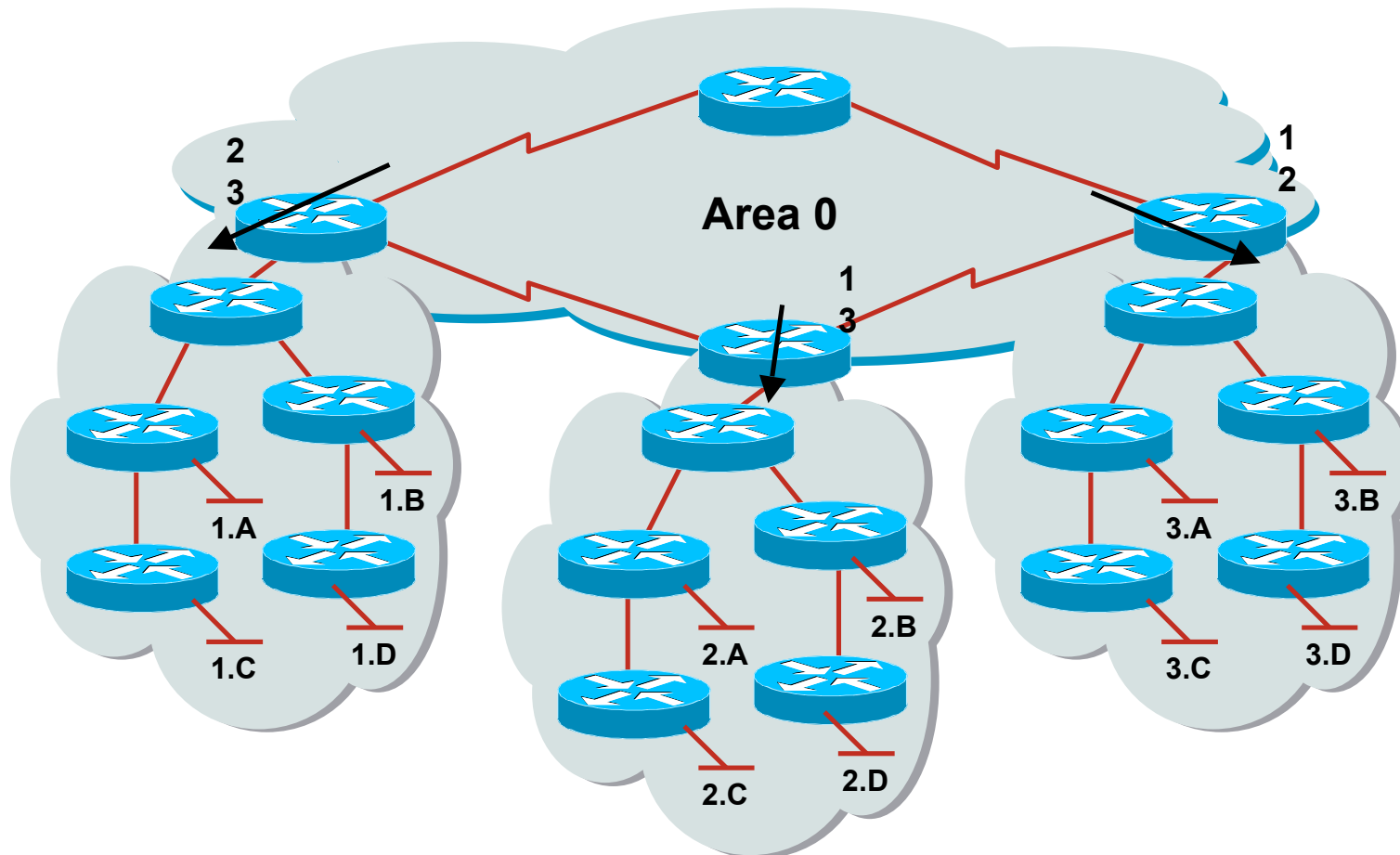

Types of Areas

- Regular
- Stub
- Totally Stubby
- Not-So-Stubby
- **Only “regular” areas are useful for ISPs**
 - Other area types handle redistribution of other routing protocols into OSPF – ISPs don’t redistribute anything into OSPF

Regular Area (Not a Stub)

- From Area 1's point of view, summary networks from other areas are injected, as are external networks such as X.1

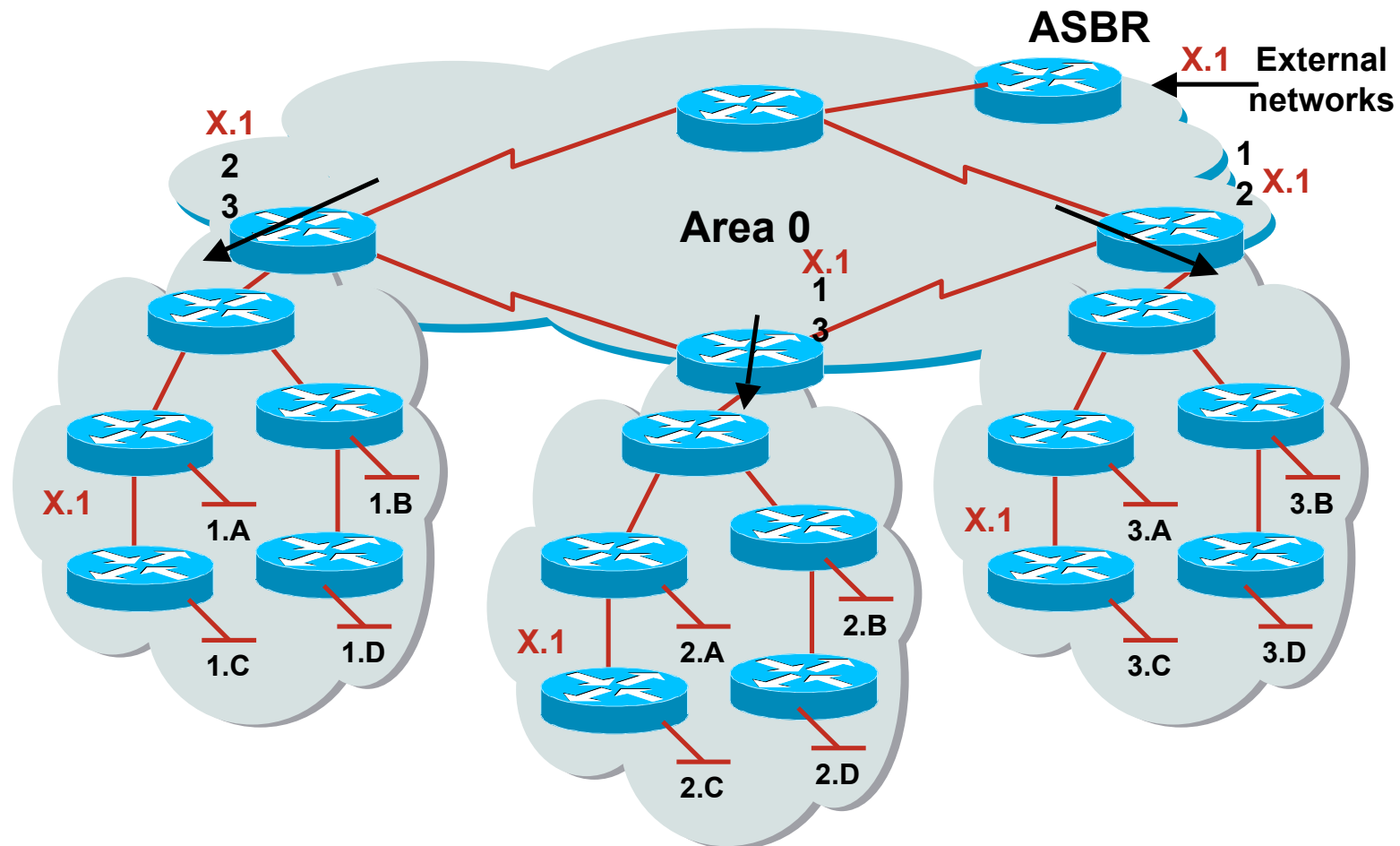

Normal Stub Area

- Summary networks, default route injected
- Command is `area x stub`

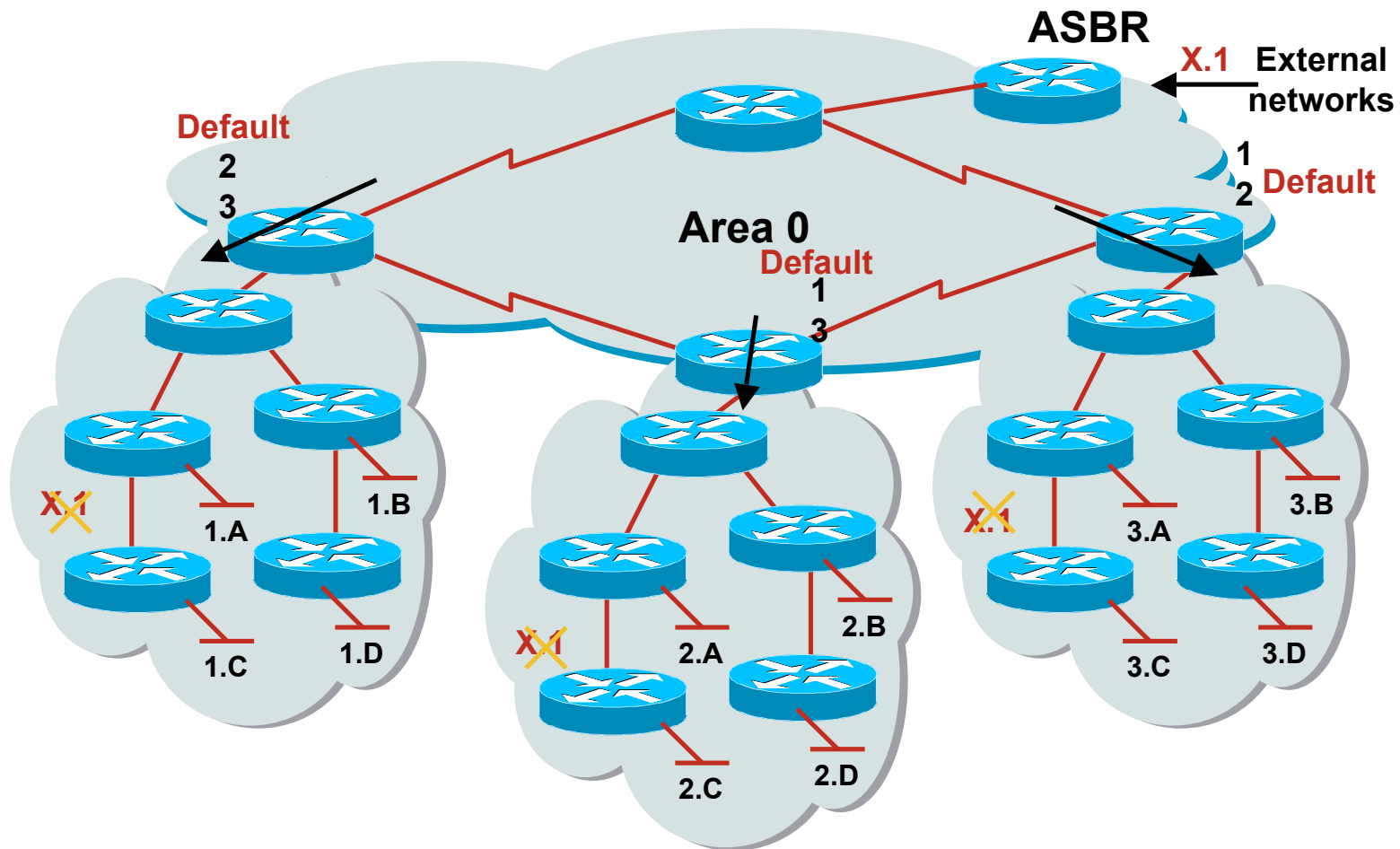

Totally Stubby Area

- Only a default route injected
Default path to closest area border router
- Command is `area x stub no-summary`

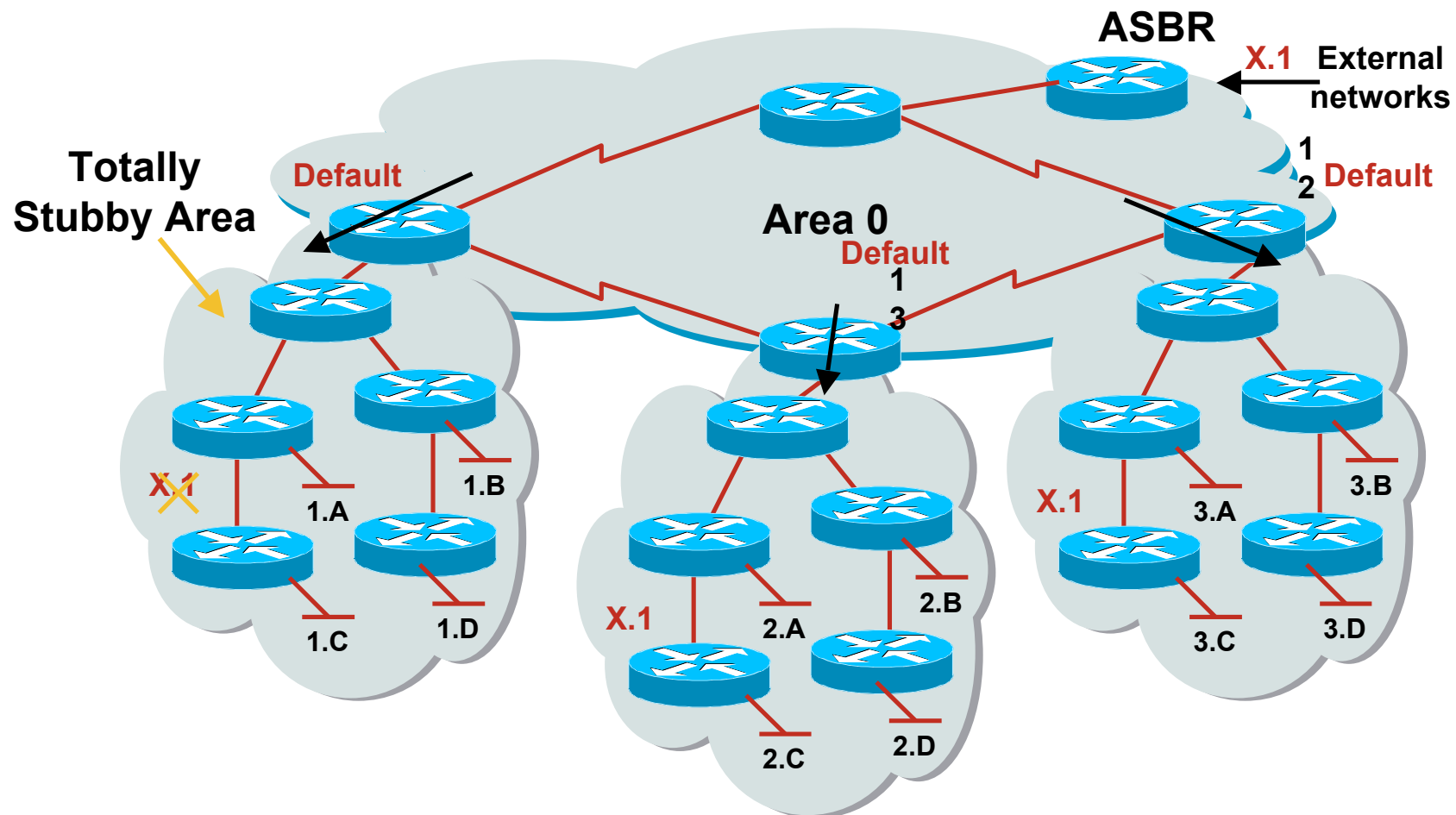

Not-So-Stubby Area

- Capable of importing routes in a limited fashion
- Type-7 LSA's carry external information within an NSSA
- NSSA Border routers translate selected type-7 LSAs into type-5 external network LSAs

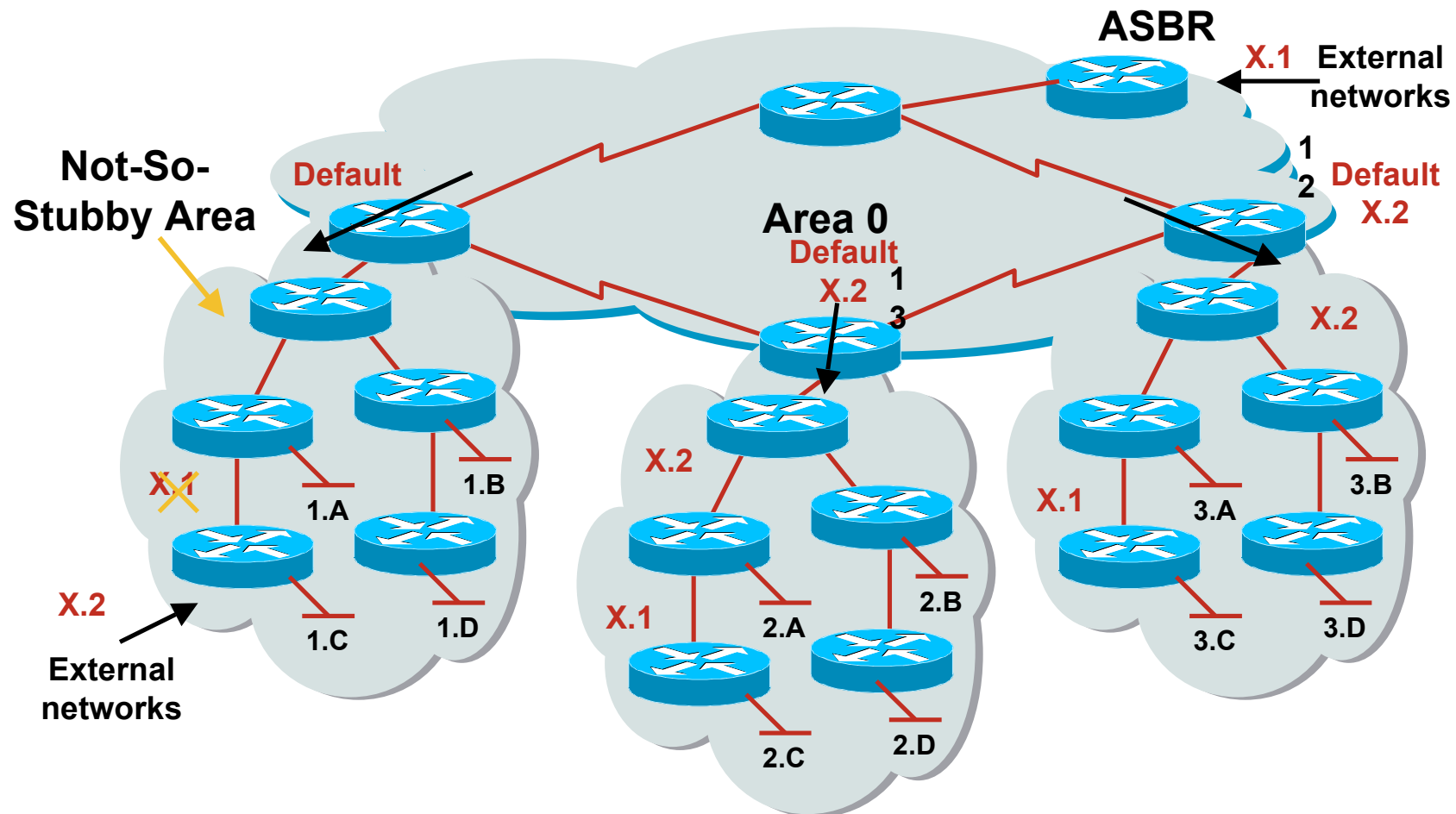

ISP Use of Areas

- ISP networks use:
 - Backbone area
 - Regular area
- Backbone area
 - No partitioning
- Regular area
 - Summarisation of point to point link addresses used within areas
 - Loopback addresses allowed out of regular areas without summarisation (otherwise iBGP won't work)

Addressing for Areas

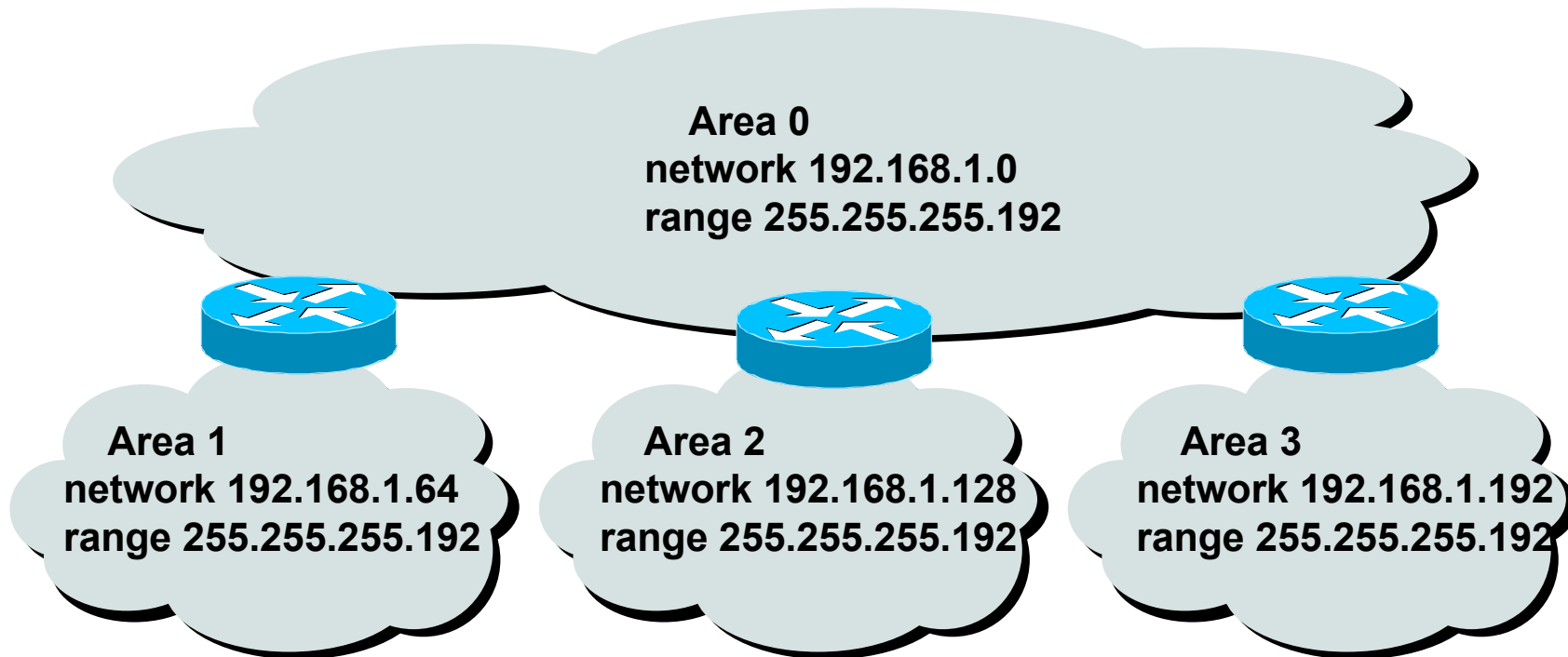

- Assign contiguous ranges of subnets per area to facilitate summarisation

Summary

- Fundamentals of Scalable OSPF Network Design

- Area hierarchy

- DR/BDR selection

- Contiguous intra-area addressing

- Route summarisation

- Infrastructure prefixes only



Introduction to OSPF

ISP/IXP Workshops